

Solution for Installer

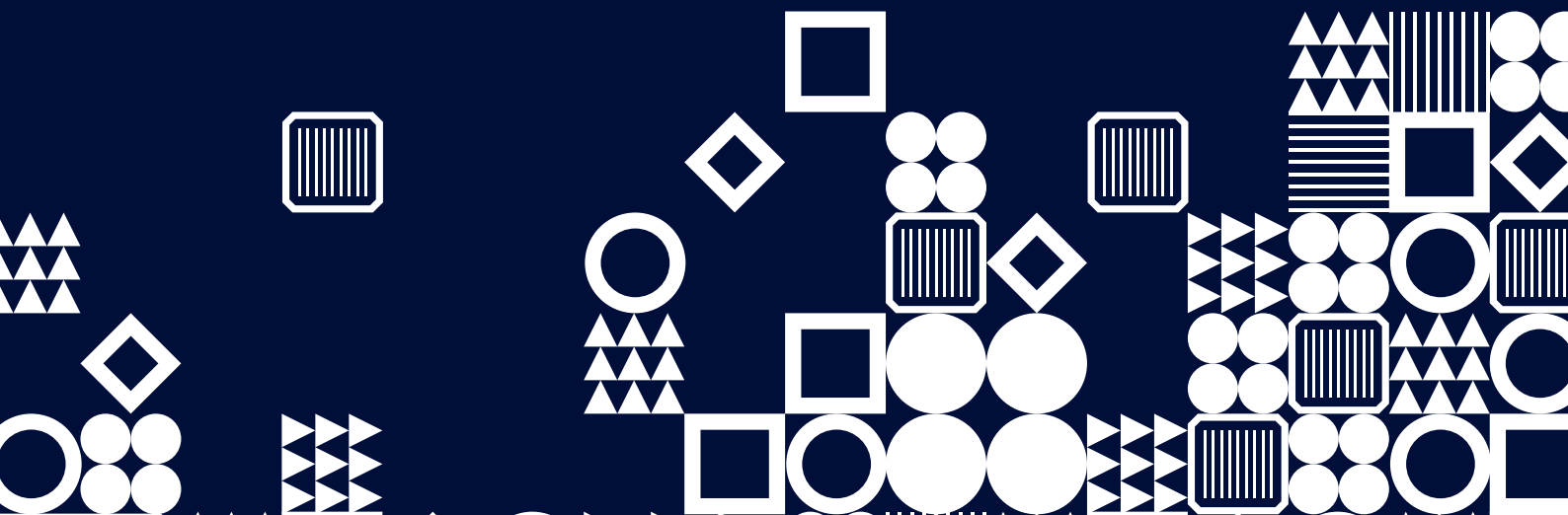

Avantages ISY-BOX



Gain de temps
Préparation simplifiée

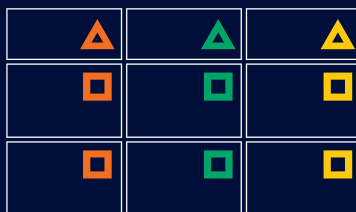

Suivi garanti
Codes couleurs et formes =
aucune erreur de comptage

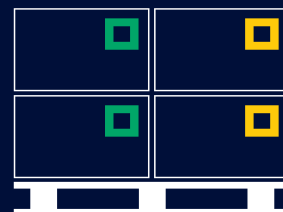

Stockage facilité
Livraison optimisée
Longueur standard

Système ISY-PV®

25 ANS
GARANTIE

- Meilleur rapport qualité / prix du marché
- Validé sous ETN n° A.21.05723
- Rails blacks pour une finition esthétique premium
- Gain de temps significatif à la pose
- Rails 1.20m faciles à manipuler
- Raccords de rails à glisser

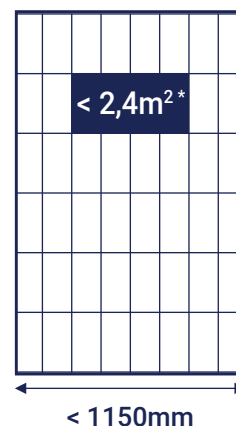

* pour des panneaux supérieurs à 2,4 m², se référer au calculateur à la pièce pour valider la nécessité d'une troisième ligne de rail par exemple.

1 Fixer le crochet ou tirefond

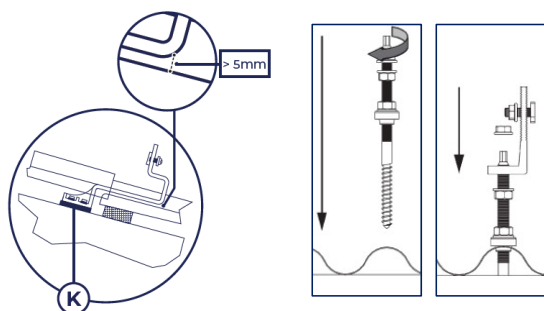

2 Assembler les rails avec les raccords

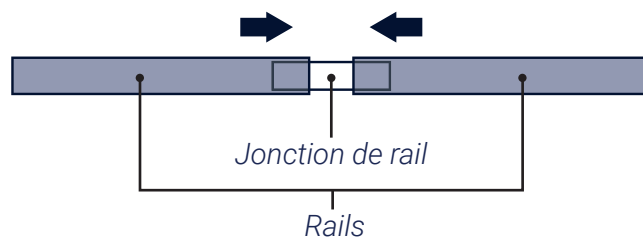

3 Fixer les rails aux crochets/tirefonds

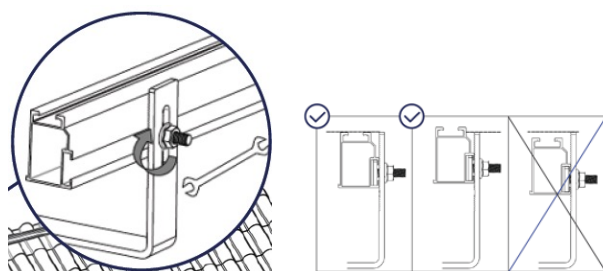

4 Fixer les modules aux rails

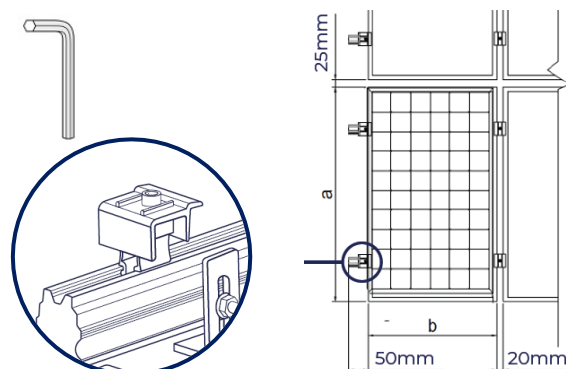

5 types de supports - 2 cartons : Une adaptabilité à tous vos chantiers



Tulie Mécanique

383002 383007

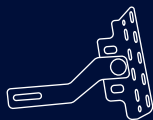

Ardoise

383003 383008

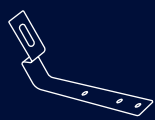

Tuile Plate

383004 383009



Tirefonds Bois

383001 383006

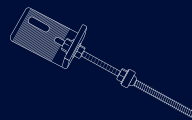

Tirefonds Métal

383005 383010

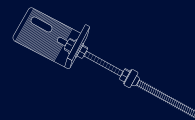

Configurations

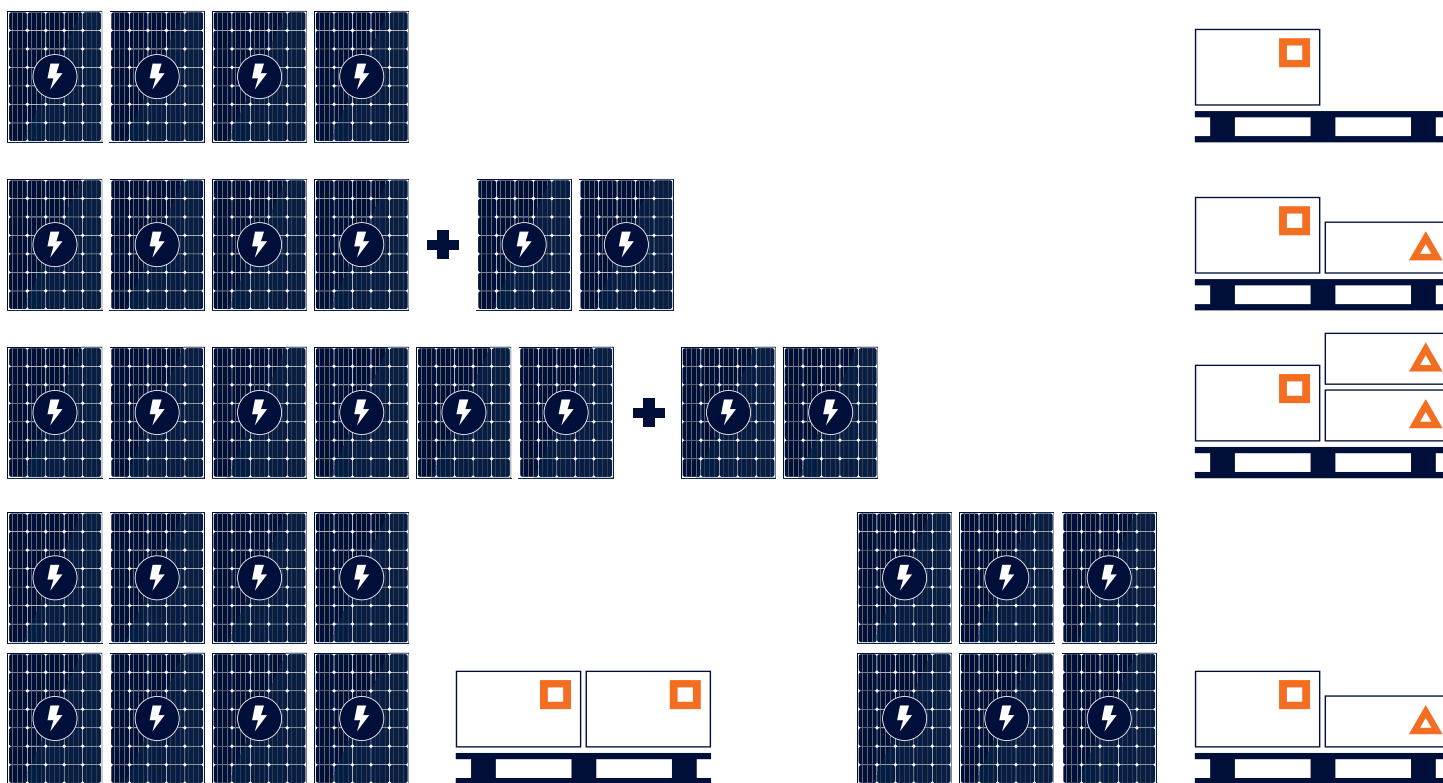

Autres configurations



Retrouvez l'outil ISY-BOX - toolkit pour dimensionner vos installations en quelques clics

ISY-IPV **Calculatrice ISY-PV BOX**

Exemple:
Couverture: Tulie mécanique
Nb. Ligne: 1
Nb. Colonne: 6





www.isy-pv.com

MARQUE FRANÇAISE

