

FIMER



Installation manual

FIMER FLEXA AC Wallbox

SAFETY INSTRUCTIONS

 **ATTENTION** – This manual contains important safety instructions that must be followed during installation and maintenance of the equipment.

KEEP THIS MANUAL

 **READ THE MANUAL** – Keep this document in a safe place for easy access at all times during installation and maintenance.

THE INSTALLER MUST READ THIS DOCUMENT IN ITS ENTIRETY BEFORE INSTALLING THE EQUIPMENT

 **READ THE MANUAL** – Operators are required to read this manual and to comply strictly with the instructions it contains.

FIMER cannot be held responsible for damage caused to persons and/or property, or to the equipment, if the conditions described below have not been complied with.

The purpose of this document is to support qualified technicians, who have received appropriate training and/or have demonstrated adequate skills and knowledge in the construction, installation, operation and maintenance of electrical equipment.

The warranty requirements are contained in the Terms and Conditions of Sale section included with the purchase order for this product.

 **NOTE** – Any modification not approved by FIMER will immediately invalidate the product warranty.

WARRANTY AND DELIVERY CONDITIONS

The warranty conditions are considered valid if the customer complies with the instructions contained in this manual; any deviation from the warranty conditions with respect to what is described below must be expressly indicated in the purchase order.

FIMER declares that the equipment complies with the legal provisions currently in force in the country of installation and has issued the relative declaration of conformity.

FIMER assumes no responsibility for failure to comply with the instructions for proper installation and cannot be held responsible for the systems upstream or downstream of the equipment supplied.

It is absolutely forbidden to modify the equipment. Any modification, manipulation or alteration of the hardware or software not expressly agreed with the manufacturer will immediately void the warranty. Due to the large number of possible combinations of system configurations and installation environments, it is essential to check the following before installing the product: adequate space for housing the equipment, ambient noise produced by the environment and possible flammable conditions.

FIMER cannot be held responsible for defects or malfunctions deriving from: improper use of the equipment; deterioration due to transport or particular environmental conditions; incorrect or insufficient maintenance; tampering or unsafe repairs; use or installation by unqualified persons.

FIMER is not responsible for any disposal of the equipment, or part of it, that does not comply with the regulations and laws in force in the country of installation.



PURPOSE AND STRUCTURE OF THE DOCUMENT

This user and maintenance manual is a guide to help you to work safely and carry out the necessary operations to keep your equipment in good working order.

If the equipment is used in a manner not specified in this manual, the protection provided by the equipment may be impaired.

This document was originally written in Italian. Therefore, in case of inconsistencies or doubts, ask FIMER for the original document.

LIST OF DOCUMENTS IN THE APPENDIX

-  **READ THE MANUAL** – In addition to this user manual, product documentation can be consulted and downloaded by visiting www.fimer.com.
-  **READ THE MANUAL** – This document only contains the information deemed necessary for the use and routine maintenance of the equipment.

SKILLS AND REQUIREMENTS OF THE OPERATOR AND MAINTENANCE PERSONNEL





-  **READ THE MANUAL** – Personnel involved in the use, maintenance and installation of the equipment must be qualified by FIMER (by means of a letter certifying their qualification) for the activities described and must reliably demonstrate their ability to correctly interpret what is described in the manual.
-  **ATTENTION** – The installation must be carried out by FIMER-qualified installers and/or FIMER-authorized electricians in accordance with the regulations in force in the country of installation and in compliance with all safety regulations for carrying out electrical work.
-  **FORBIDDEN** – It is forbidden to entrust the installation or maintenance of the product to unqualified persons or those in an altered physical or mental state.
-  **ATTENTION** – The customer bears civil responsibility for the qualification and mental or physical state of the personnel who handle the equipment. Such personnel must always use the personal protective equipment (PPE) required by the laws of the country of destination and by the instructions of their employer.

Table of content

1. *General information*

1.1	Fields of use	7
1.2	Symbols and definitions	8
1.3	Product dimensions and features	10
1.4	Available models and versions	11
1.4.1	Features of Stand Alone model	11
1.4.2	Features of Inverter Net model	11
1.4.3	Features of Future Net model	11
1.4.4	Master/Slave functionality	12
1.5	Support	12
1.6	Technical data	13

2. *Safety and equipment*

2.1	Safety warnings	14
2.2	Proper use	14
2.3	Product handling	15

3. *Installation*

3.1	Preparing for installation	16
3.2	Tools required	17
3.3	Package contents	17
3.4	Space and positioning	18
3.5	Unpacking	19
3.6	Wall mounting plate installation	20
3.7	FLEXA AC Wallbox installation	21
3.8	Connection of power and earth cables	22
3.9	Residual-Current device management	26
3.10	Communication cables connection	28
3.11	Port description	29
3.11.1	AC Relé OUT-J31	30
3.11.2	CT Sensor – J4	30
3.11.3	Gigabit Ethernet	31
3.11.4	RS-485 Smart Grid-J5	31
3.11.5	RS-485 Mid Meter-J6	34

3.12	Dynamic Power Management	35
3.12.1	CT sensor installation	35
3.12.2	External meter installation	36
3.12.3	FLEXA AC Wallbox Inverter Net and REACT 2 integration	38
3.12.4	FLEXA AC Wallbox integration with solar inverters	40
3.13	Closing operations and power supply	41
4.	<i>First start-up and configuration</i>	
4.1	LED behavior	42
4.2	LED behavior during operation	43
5.	<i>Operating instructions</i>	
5.1	Preliminary charging operations	44
5.2	Charging operations	45
5.2.1	Open access	46
5.2.2	Remote authentication	46
5.2.3	Local RFID	47
5.2.4	Authentication via service center	47
5.3	RFID card operations	48
5.4	MyFIMERwallbox App	49
5.4.1	FLEXA AC Wallbox pairing	49
5.4.2	View, add and delete your FLEXA AC Wallbox	49
5.4.3	Firmware upgrade	50
5.4.4	DPM activation	50
5.4.5	User limit setting	50
5.4.6	Charging modes	51
5.4.7	Consumption	51
5.4.8	Monitoring consumption in multi-user applications	51
5.4.9	Active alarms	52
6.	<i>Troubleshooting</i>	
6.1	Alarms and warnings	53
6.1.1	Global alarms	54
6.1.2	Global warnings	54
6.1.3	Socket alarms	55
6.1.4	Socket warnings	55
7.	<i>Maintenance</i>	
8.	<i>Decommissioning and disposal</i>	

1. General information

1

FIMER FLEXA AC Wallbox is the AC charging solution for powering electric vehicles, ideal for public, semi-public and residential applications: it is available in single-phase or three-phase configurations and can be equipped with a Type 2 SOCKET or a Type 2 CABLE or a Type 3A SOCKET (according to the IEC 62196-2 standard). Other types of connectors are not supported.

Characterised by significant robustness and ease of use, this device allows you to charge an electric vehicle up to a maximum of 22 kW (with Type T2 socket or cable) or up to 3.7 kW (with Type 3A socket).

⚠ ATTENTION – Prepare and size the entire power supply system in compliance with the local and international standards in force according to the product version and the power rating chosen.

📖 READ THE MANUAL – This document describes how to install, configure, and maintain the product.

A description of the features of the equipment is provided to identify its major components and specify the technical terminology used in this manual.

This chapter contains information on models, details on equipment, features and technical data, overall dimensions and identification of the equipment.

In some cases, it may be necessary to document the software configuration features separately by consulting additional documentation to this manual intended for specialised FIMER-trained technicians (e.g. sim data, etc.).



1.1 Fields of use

FIMER shall not be liable for damage of any kind resulting from incorrect or careless operations.







🚫 FORBIDDEN – The equipment may not be used for any purpose other than that intended in the field of use. The equipment must not be used by inexperienced personnel, or even by expert personnel if operations are carried out on the equipment that do not comply with this manual and the accompanying documentation.

This equipment is a charging device for electric vehicles; the following classification (according to IEC 61851-1) identifies its characteristics:

- Power supply: permanently connected to the AC power supply grid
- Output: alternating current
- Environmental conditions: outdoor use
- A device for places with free access
- Fixed installation on wall or dedicated FIMER FLEXA Stand-Basic
- Protection against electric shock: Class I
- Charging type: Mode 3 according to the IEC 61851-1 standard
- Optional function for ventilation not supported









-  **ATTENTION** – In case of installation in TN-type earthing systems, there may be additional specific local regulations regarding system safety and protection against faults that the installer must understand and implement.
-  **ATTENTION** – The device can be used for the European and Australian markets, as up to date certifications have been issued.

IT IS STRICTLY PROHIBITED TO:

-  **FORBIDDEN** – Install the equipment in environments subject to particular flammability conditions or in adverse or unpermitted environmental conditions
-  **FORBIDDEN** – Use the equipment with defective or disabled safety devices
-  **FORBIDDEN** – Use the equipment or parts of the equipment by connecting it to other machines or equipment, unless expressly provided for
-  **FORBIDDEN** – Modify operating parameters that are not accessible to the operator and/or parts of the equipment to alter its performance or make changes to its insulation
-  **FORBIDDEN** – Clean the product with corrosive products that could damage parts of the equipment or generate electrostatic charges
-  **FORBIDDEN** – Use or install the equipment or any associated parts thereof without having read and properly understood the contents of the operation and maintenance manual

1.2 Symbols and definitions

In this manual and/or in some cases on the equipment, dangerous zones/components are indicated by signs, labels, symbols or icons.

Symbol	Description
	GENERAL WARNING
	IT IS MANDATORY TO CONSULT THE ORIGINAL MANUAL AND ADDITIONAL DOCUMENTATION
	PROHIBITION OR RESTRICTIONS
	IT IS COMPULSORY TO PERFORM THE DESCRIBED OPERATIONS USING THE CLOTHING AND/OR PROTECTIVE EQUIPMENT PROVIDED BY THE EMPLOYER
	ALTHOUGH THEY ARE NOT MADE OF MATERIALS THAT ARE HARMFUL TO HEALTH, THE PRODUCTS SHOULD
	SIGN FOR ELECTRICAL VOLTAGE HAZARD
	SIGN FOR OBLIGATION TO READ THE INSTRUCTIONS
	ELECTRONIC DEVICE INSTALLATION CARRIED OUT BY QUALIFIED PERSONNEL ONLY

With respect to the symbols on the product's nameplate, we shall identify the labeling not shown above as follows:

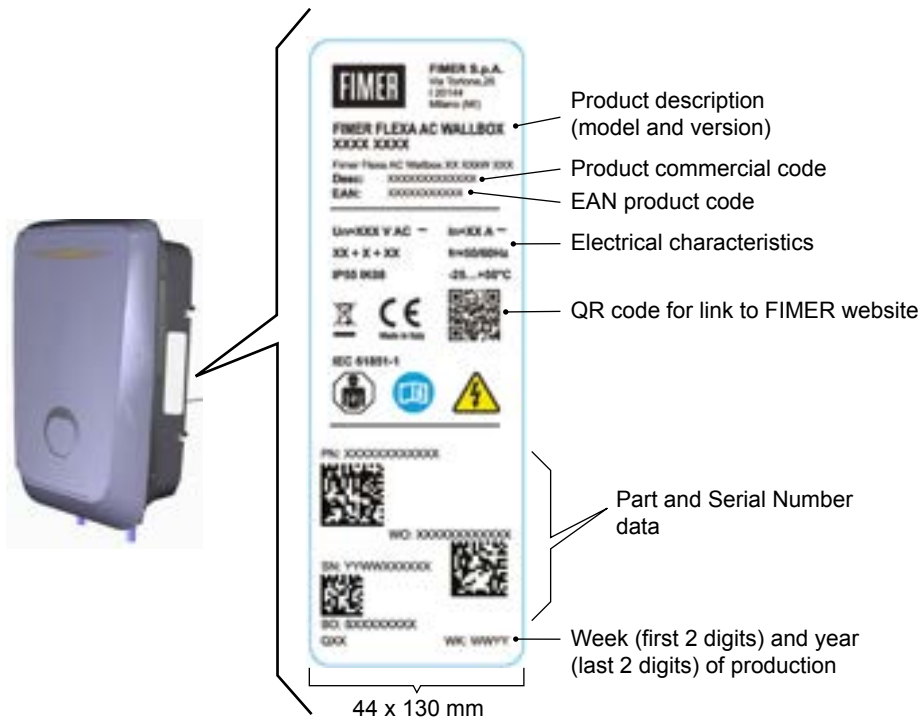

1.3 Product dimensions and features

Weight: 7 kg (socket version) and 8.5 kg (cord version)

Dimensions: 300 x 480 x 145 mm (socket version),
300 x 480 x 220 mm (cord version)

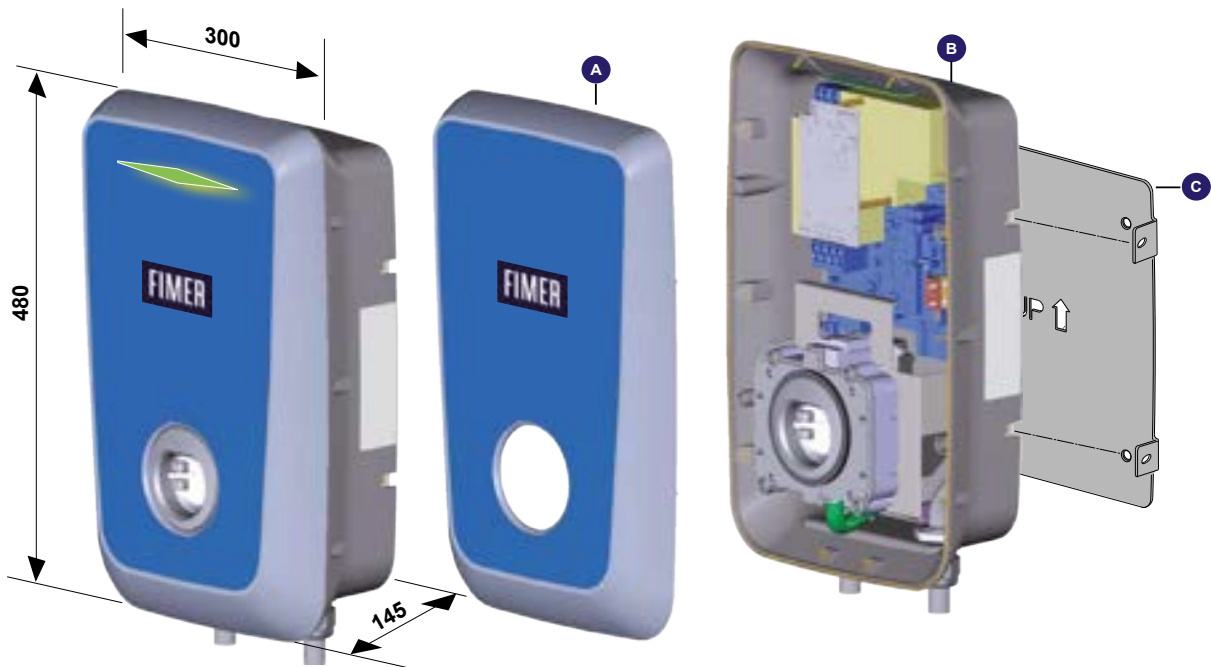

- A. FRONT COVER
- B. REAR CASING
- C. FIXING PLATE

1.4 Available models and versions

The product is available in three models:

- Stand Alone
- Inverter Net
- Future Net



Each model has three available versions depending on the connection to the vehicle:

- T2C, with cable T2
- T2S, with socket T2
- T3A, with socket T3A

Four power configurations and corresponding versions are available for each model, depending on the type of connection to the vehicle:

Power	Available Sockets & Plugs
3.7 kW	T3A, T2S, T2C
7.4 kW	T2S, T2C
11 kW	T2S, T2C
22 kW	T2S, T2C

Near the socket of products supplied in T2S and T3A versions, there is a label identifying the type of socket installed on the product.

Stand Alone, Inverter Net and Future Net T2S version	AC	EN 62192-2	TYPE 2	Plug and socket	$\leq 480 V_{RMS}$	
Stand Alone, Inverter Net and Future Net T3A version	AC	EN 62192-2	TYPE 3A	Plug and socket	$\leq 480 V_{RMS}$	

1.4.1 Features of Stand Alone model

FIMER FLEXA AC Wallbox Stand Alone charges the electric vehicle in Mode 3, in 'Open Access' mode or via local authentication with RFID card. The device can connect to its dedicated App (MyFIMERwallbox) via Bluetooth, allowing the user to monitor charging status and consumption, modify operating settings, pause and restart charging, manage associated cards and check eventual alarms. The Wallbox is equipped with a LED to identify the status of the device.

1.4.2 Features of Inverter Net model

FIMER FLEXA AC Wallbox Inverter Net maintains the same features as the Stand Alone model, integrating communication with FIMER REACT 2 inverter via ModBus RS-485. In addition, through the inverter management system (Aurora Vision®), both monitoring activities of operation and parameters of the device and remote control or management activities are available. For an explanation of these functionalities, please refer to the FIMER REACT 2 solar inverter instruction manual and related Aurora Vision® documentation.

1.4.3 Features of Future Net model

FIMER FLEXA AC Wallbox Future Net integrates connectivity features that enable remote monitoring and management of the device.

Unlike the other two, the Future Net model can connect to a backend via OCPP 1.6 Json protocol, connecting with a 3G/4G SIM, Wi-Fi or via Ethernet. Authentication to start charging can take place via the associated backends' App and via the service center's RFID card.

1.4.4 Master/Slave functionality

In applications with multiple charging points, FIMER FLEXA AC Wallbox provides Master/Slave functionality, offering a competitive, smart and efficient solution thanks to its integrated load management system.

The Master/Slave function allows the Future Net model to be connected with multiple Stand Alone models, up to a total of 32 devices, via an RS-485 connection.

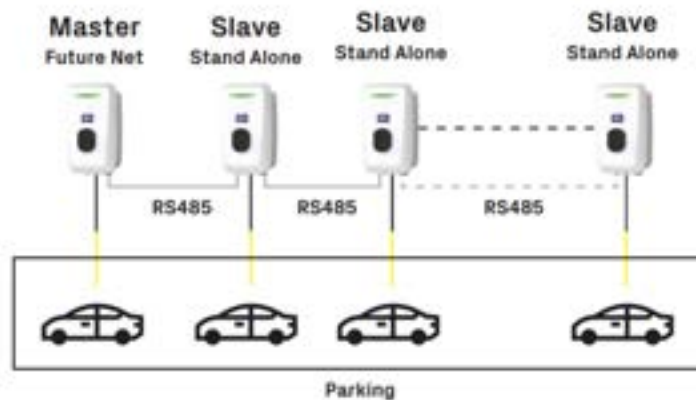

THE CHARGING POLICIES AVAILABLE IN THE M/S CONFIGURATION ARE:

FIFO

With this charging policy, the EVs can be charged one at a time according to the arrival order. For 30 minutes (configurable) a complete charge cycle is provided, giving priority to the first who arrived. The last car to arrive will go in the queue of all cars that have not yet made a first charge cycle but will precede cars that have already made a charge cycle.

EXTENDED FIFO

Multiple EVs can be charged simultaneously. Based on the order of arrival, as many cars as possible will be charged at maximum current. At the end of the maximum charging cycle, the cars will divide the remaining available current equally. The limitation depends on the plant current set point.

DEMOCRATIC FIFO

Multiple EVs can be charged at the same time. Based on the order of arrival, only one car is charged to the maximum while the others share the remaining current. When all cars have done a maximum charging cycle, then all will share the available residual current. The limitation depends on the plant current set point.

FULL DEMOCRATIC

Multiple EVs can be charged at the same time. All cars will share the available current equally. The limitation depends on the plant current set point.

These charging policies can be set through the EVI Tool.

1.5 Support

For any reports or requests for further support, FIMER is available through the dedicated section of the website www.fimer.com or by writing to service.emobility@fimer.com.

1.6 Technical data

Technical data				
FIMER FLEXA AC Wallbox model	Stand Alone / Inverter Net / Future Net			
Maximum power	3.7 kW	7.4 kW	11 kW	22 kW
Standard	IEC 61851-1:2017, IEC 61851-21-2:2018			
Charging method	Mode 3			
Available outlets	5m Cord (T2) or Socket (T2 or T3A)			
Power system	1P + N + PE	1P + N + PE	3P + N + PE	3P + N + PE
Rated voltage ¹⁾	230 V _{AC} ± 10% 110 V _{AC} L-G 220 V _{AC} L-L	230 V _{AC} ± 10% 110 V _{AC} L-G 220 V _{AC} L-L	400 V _{AC} ± 10% 480 V _{AC} ± 10%	400 V _{AC} ± 10% 480 V _{AC} ± 10%
Frequency	50/60 Hz			
Rated current	16 A	32 A	16 A	32 A
Rated impulse withstand voltage (Uimp)	4 kV			
Rated withstand short-circuit current (Isc)	10 kA			
Pollution degree	PD2			
EMC classification	Class B emissions			
Protective measures against electric shock	Class I			
Connection to the supply network	Permanently connected			
Grounding system type	TT or TN (both with PE)			
Installation	Indoor/Outdoor			
Fixed or removable installation	Fixed			
Overvoltage category	III			
IP protection rating	IP 55			
IK protection rating	IK 08			
Case material	100% recycled plastic			
Dimensions	300 x 480 x 145 mm (Socket), 300 x 480 x 220 mm (Cord)			
Weight	7 kg (Socket), 8.5 kg (Cord)			
Operating temperature	-25...+50°C			
Storage temperature	-25...+70°C			
Humidity	0...95% (non-condensing)			
Altitude	Up to 2000 m			
Product intended for use by	Unskilled persons			
Positioning in area with	Non-restricted access			
Magnetothermal protection	Not included			
Differential protection	Not included (equipped with 6 mA _{DC} RCM)			
Energy meter	Compatible with external MID meters or CT sensor			
Certification ²⁾	CE, RCM, UL, TR:2015, VDE AR-N 4100			

Specific features												
FIMER FLEXA AC Wallbox model	Stand Alone				Inverter Net				Future Net			
	3.7 kW	7.4 kW	11 kW	22 kW	3.7 kW	7.4 kW	11 kW	22 kW	3.7 kW	7.4 kW	11 kW	22 kW
Bluetooth
RFID reader
OCP									1.6 Json	1.6 Json	1.6 Json	1.6 Json
3G/4G connection								
Ethernet connection								
Wi-Fi								
Status LED
CT meter included		

1) Please contact FIMER to check the availability of different rated voltages

2) Please contact FIMER to check the certification status

2. *Safety and equipment*

2

2.1 Safety warnings

- ⚠ **ATTENTION** – Please read this document carefully before installing and starting up the product.
- ⚠ **ATTENTION** – The installation and start-up phases of the device should only be carried out by qualified personnel who are able to identify hazards and act safely.
- ⚠ **ATTENTION** – Even the maintenance, repair or subsequent repositioning phases must be carried out only by qualified personnel: there are no components that can be repaired by the user or maintained independently.

- ⚠ **WARNING** – Children or persons not deemed capable of assessing the risks involved in the installation must not handle the product.
- ⚠ **WARNING** – Both domestic and non-domestic animals must be kept away from the equipment.
- ⚠ **WARNING** – Failure to observe all or part of the instructions in this document may lead to serious or fatal injury.
- ⚠ **WARNING** – The qualified installer must always ensure that the installation is carried out in accordance with the local regulations in effect at the time of installation.

2.2 Proper use

- ⚠ **ATTENTION** – The device requires an earth connection via a dedicated equipotential cable, to be connected to the earth terminal inside the device.
- ⚠ **ATTENTION** – In any case, it is necessary to verify, prior to installation, that the power supply system is fully compliant with the state of the art and carried out by qualified personnel in accordance with local and international regulations.
- ⚠ **ATTENTION** – The device is only safe to use if it is used as intended.
- ⚠ **ATTENTION** – Different uses and unauthorised modifications to the appliance or to any of its components are not permissible and are therefore considered to be non-compliant.
- ⚠ **ATTENTION** – The device is designed to be connected and to communicate information and data via a network interface. It is the sole responsibility of the user to provide and ensure at all times a secure connection between the product and the user's data network or any other network (as the case may be). The user must establish and maintain all appropriate measures (such as, but not limited to, the installation of firewalls, the application of authentication measures, data encryption, the installation of anti-virus programs, etc.) to protect the product, the network, its system and interface against any type of security breach, unauthorised access, interference, intrusion, loss or theft of data or information. FIMER and its affiliates shall not be liable for any damage or losses related to any such security breaches, any unauthorised access, interference, intrusion, loss or theft of data or information. The data, examples and diagrams in this manual are only included to

describe the product and should not be regarded as a declaration of guaranteed properties. All persons responsible for installing the equipment specified in this manual must ensure that each intended installation is suitable and acceptable, including compliance with any applicable safety or other operational requirements. In particular, any risk in applications where a system failure or product failure would create a risk of damage to property or persons (including but not limited to personal injury or death) shall be the sole responsibility of the person or entity installing the equipment, and those responsible for it are advised to ensure that all measures are taken to eliminate or mitigate such risks.

 **ATTENTION** – This document has been carefully checked by FIMER but deviations cannot be completely ruled out. If errors are detected, the reader is kindly asked to notify FIMER. Except for explicit contractual commitments, in no case can FIMER be held responsible for any loss or damage resulting from the use of this manual or from the installation of the equipment.

 **ATTENTION** – The product should not be displayed freely on the internet. In order to ensure maximum security of information and operation, it is necessary for the device to remain protected from any attempt to connect to it from the internet. Therefore any communication should only originate from the device and not the other way around.

 **ATTENTION** – If you require further information, support or wish to make a report regarding cyber security, please write to the e-mail address itfeb.cybersecurity@fimer.com.

2.3 Product handling

 **WARNING** – The total weight of the product without packaging is approximately 7 kg for the Socket version and 8.5 kg for the Cable version: be sure to use suitable equipment for handling it.

 **WARNING** – Transport and store in a dry place away from heat sources (following the technical guidelines) in the original packaging only.

 **WARNING** – Never grasp the product by the charging cables or connectors.

3. Installation

3

⚠ ATTENTION – Failure to observe the instructions given in this manual may cause serious damage to both the product and the installer (in the most serious cases, injuries may be fatal). Please read this manual carefully before installing, starting up and using the product. FIMER recommends using experienced professionals who comply with current regulations to install the product correctly.

The following table shows the main local restrictions prescribed in the IEC 61851-1 standard that the installer must consider before selecting and installing the device. However, it remains responsibility of the installer to verify that these regulations are still in effect and above all to check whether additional local regulations apply and could restrict the use of these devices in the country of choice:

Country	National restrictions
IT	For CABLE T2 and T3A SOCKET versions, an additional device capable of interrupting the power supply must be used (see External Residual-Current Device Management)
NL	For CABLE T2 and T3A SOCKET versions, an additional device capable of interrupting the power supply must be used (see External Residual-Current Device Management)
FR	CABLE T2 and T3A SOCKET versions cannot be used in residential and public applications
UK	CABLE T2 and T3A SOCKET versions cannot be used in residential and public applications
DK	CABLE T2 and T3A SOCKET versions cannot be used in residential and public applications
ES	CABLE T2 and T3A SOCKET versions cannot be used in residential applications and for all applications up to 16 A
SE	CABLE T2 and T3A SOCKET versions cannot be used

3.1 Preparing for installation

Before proceeding with the installation, make sure that:

- Input power is completely switched off and remains so until installation is complete
- The work area is adequately cordoned off (access by person who are not involved in the work must be prevented)
- Installation should not be carried out with wet hands and no water jet should be directed towards the product
- Installation should not be carried out in rain, fog or high humidity
- The product packaging is completely intact and without any obvious damage (if the product is damaged, contact your seller or request support at www.fimer.com)
- The product and all components (including cables) are completely intact and without any obvious defects or faults

⚠ ATTENTION – To ensure correct operation of the product in line with the local regulations in effect, calculate the distance between the power supply panel and the installation site to determine the voltage drop, cable thickness and existing load, which are useful for identifying the maximum operating current.

⚠ ATTENTION – The entire electrical system to which the product is connected must first be correctly sized by a qualified professional. The device's electrical data, which should be referred to in order to correctly size the power supply system, are displayed on the device's nameplate.

⚠ ATTENTION – Product installation must comply with all applicable local and international standards in force for the construction and installation of electrical/electronic equipment, including, but not limited to, the IEC 60364-1 and IEC 60364-5-52 standards.

The power supply system must meet the following requirements:

A TN or TT system, in both cases with a PE cable

Power supply:

- **Models with three-phase connection:** : $400 V_{AC} \pm 10\%$ - 50/60 Hz
- **Models with single-phase connection:** $230 V_{AC} \pm 10\%$ - 50/60 Hz
- **Models with single-phase connection:** $110 V_{AC} \pm 10\%$ L-G, $220 V_{AC} \pm 10\%$ L-L - 50/60 Hz
- **Models with three-phase connection:** $480 V_{AC} \pm 10\%$ - 60 Hz

3.2 Tools required





- Cutter
- Flathead screwdriver or screw gun
- Marker/pencil
- Drill and 8 mm diameter bit suitable for the material of the fixing surface to be drilled
- Hex keys
- Wire stripping pliers

⚠ ATTENTION – FIMER accepts no liability for damage to property or persons deriving from the use of these tools. Installation must be performed by qualified personnel and in compliance with the regulations in place for the installation of electrical equipment.

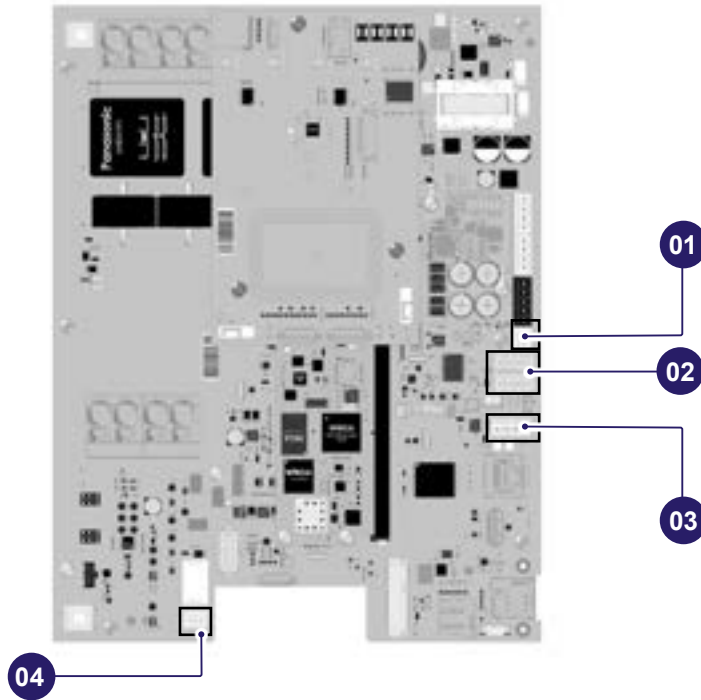
3.3 Package contents

- N.1 FIMER FLEXA AC Wallbox
- N.1 fixing plate
- N.4 8x40 wall anchors
- N.14 40x14 screws
- N.4 white caps
- N.1 "4 holes" gasket
- N.3 RFID cards (N.1 Master and N.2 Slave) for Stand Alone and Inverter Net models
- User counterparts connector (as listed in the table below)
- Installation manual, UKCA Declaration of Conformity, warranty certificate and WEEE provisions.





N	Port types	Functionality	Picture
01	J4 Analog input 3,3 V Max. current 330 mA	Pin 1 and 2: T connection	
02	J5 4+4 poles RS-485	RS-485 ModBus for Master-Slave or REACT 2 communication	
03	J6 4 poles RS-485	RS-485 ModBus for external MID Meter	
04	J31 Normally open dry contact 3 A 250 V _{AC}	Command for upstream switching device	

3.4 Space and positioning

 **READ THE MANUAL** – Before choosing where to install the product, consult your electric vehicle manual and follow any pertinent instructions.

 **ATTENTION** – Make sure that there are no heat sources, flammable substances or electromagnetic sources in the installation area, either during installation of the product or throughout the product’s lifetime.

 **ATTENTION** – In addition, the installation site must be sufficiently ventilated to ensure proper heat dissipation. For versions of the product with mobile cellular or Wi-Fi connection, ensure that the selected area has cellular reception or Wi-Fi coverage.

 **ATTENTION** – Before installation, ensure that the environmental conditions (such as temperature, altitude and humidity) comply with the product specifications.

 **ATTENTION** – To ensure the functionality of the device and to guarantee its proper use by the user, the space around the device must be clear to allow for air circulation, cable maneuverability, charging procedures and both routine and non-routine safety maintenance operations.

 **ATTENTION** – In addition, the space needed to park the electric vehicle to be charged must be taken into account.

⚠ ATTENTION – For locations where the device will be exposed to direct sunlight or weather for most of the day, it is advisable to install a cover to protect the charging station.

In addition, for semi-public installations it is necessary to:

- Make sure that there are barriers or poles to protect the charging device from collisions;
- Design the parking layout for easy access to the charging cable;
- Provide a safe and comfortable environment for users and to prevent vandalism or theft;
- Install the charging device in a place where it can be clearly seen or monitored;
- Install sufficient lighting around the device.

3.5 Unpacking

Before installing the device, it is necessary to check, when unpacking, that the various parts of the device do not display any physical damage due to impacts, tears or abrasions. If any damage is detected, the installation procedure must be aborted immediately and technical support must be contacted.

The various components are protected by packaging and adhesive tape: before installation, each component must be cleaned of any traces of dust, packaging or adhesive tape.

The images below are for illustrative purposes and may not show all internal components of the product or may contain negligible differences from the actual configuration.

1. Open the main packaging

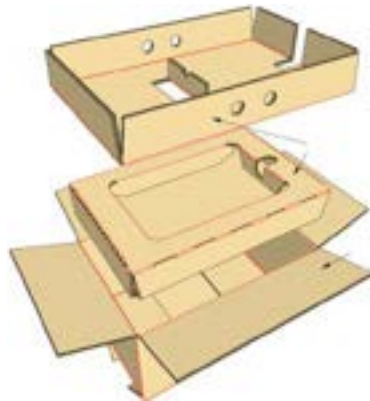

2. Using suitable handling equipment, remove the device from the casing and place it on the work surface

3. Remove the **10 screws** that hold the front cover to the rear casing and separate the two parts of the product



3.6 Wall mounting plate installation

- ⚠ ATTENTION** – The images below are for illustrative purposes and may not show all internal components of the product or may contain negligible differences from the actual configuration.
- ⚠ ATTENTION** – The product can be installed either on the wall or on a dedicated FIMER FLEXA Stand. This document shows the installation procedure for wall mounting, while the installation procedure for the FIMER FLEXA Stand is supplied with the FIMER FLEXA Stand.

1. Establish the installation location, taking into account the minimum distances from the ceiling, walls and floor provided in the drawing. The installation height of the Wallbox must be such that the lowest point of the vehicle connector when placed in its resting position is at a height of between 1.2 - 1.5 m above ground level, corresponding to the lower edge of the plate.
2. Place the fixing plate on the wall and use it as a template to make marks at the fixing holes (a) using a marker or pencil. **N.B. Pay attention to the orientation of the plate.** To ensure a more precise final position, it is best to use a spirit level to check the correct alignment of the plate to the wall when marking.
3. Remove the plate from the wall and, using a drill, make 4 holes (a) $\varnothing 8$ mm at the previously drawn marks. The minimum depth of the hole must be 60 mm. Then remove any drilling residue from the holes.
4. Separate the 4 screws from the respective 4 wall plugs $\varnothing 8 \times 40$ mm (supplied) The wall plugs supplied are universal, suitable for solid or cavity brick walls. For installation on walls made of different materials (e.g. plasterboard) specific plugs are required, which must be installed after the maximum permissible load has been verified.
5. Insert the 4 plugs into the holes just made. Place the fixing plate on the wall, matching the 4 holes in the plate to the 4 holes just drilled in the wall.
6. Secure the plate by screwing the 4 screws previously removed from the wall plugs into the corresponding plugs set into the wall.

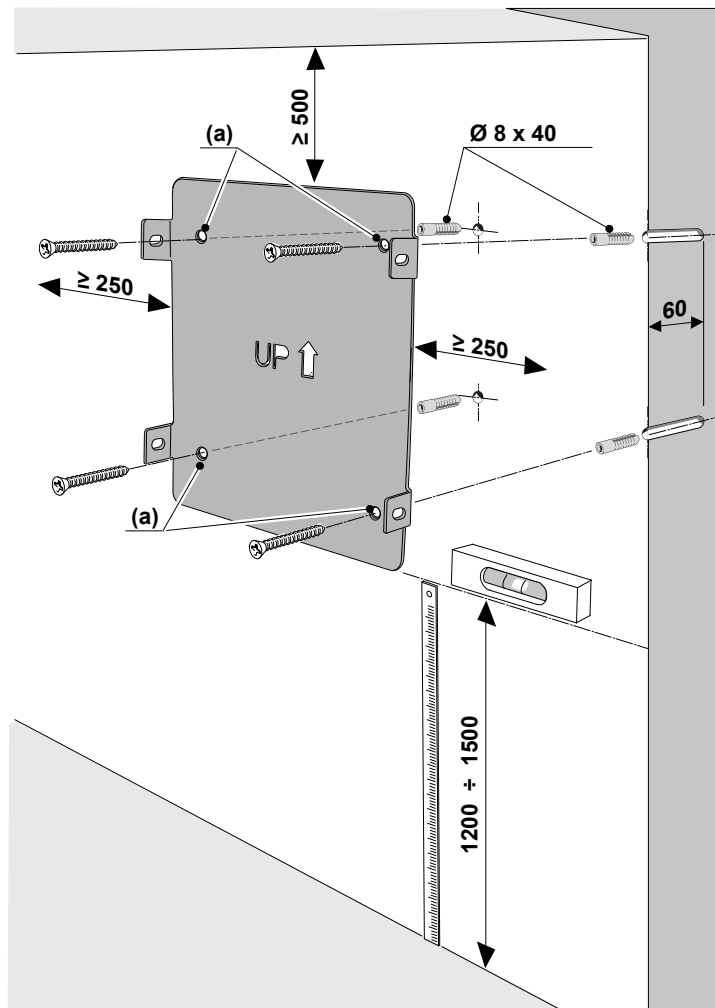

NOTE – Measurements are in mm.

3.7 FLEXA AC Wallbox installation

- ⚠ ATTENTION** – During installation, the electrical connection of the power supply must be disabled, and the entire working area must be cordoned off, with only qualified and authorised personnel able to access it.
- ⚠ ATTENTION** – The power supply to the equipment must remain switched off. Failure to follow these instructions can lead to serious damage to persons and property, including death.
- ⚠ ATTENTION** – The images below are for illustrative purposes and may not show all internal components of the product or may contain negligible differences from the actual configuration.

1. Position the Wallbox close to the wall-mounted plate, so that the four side tabs of the fixing plate correspond to the four side slots of the rear casing.

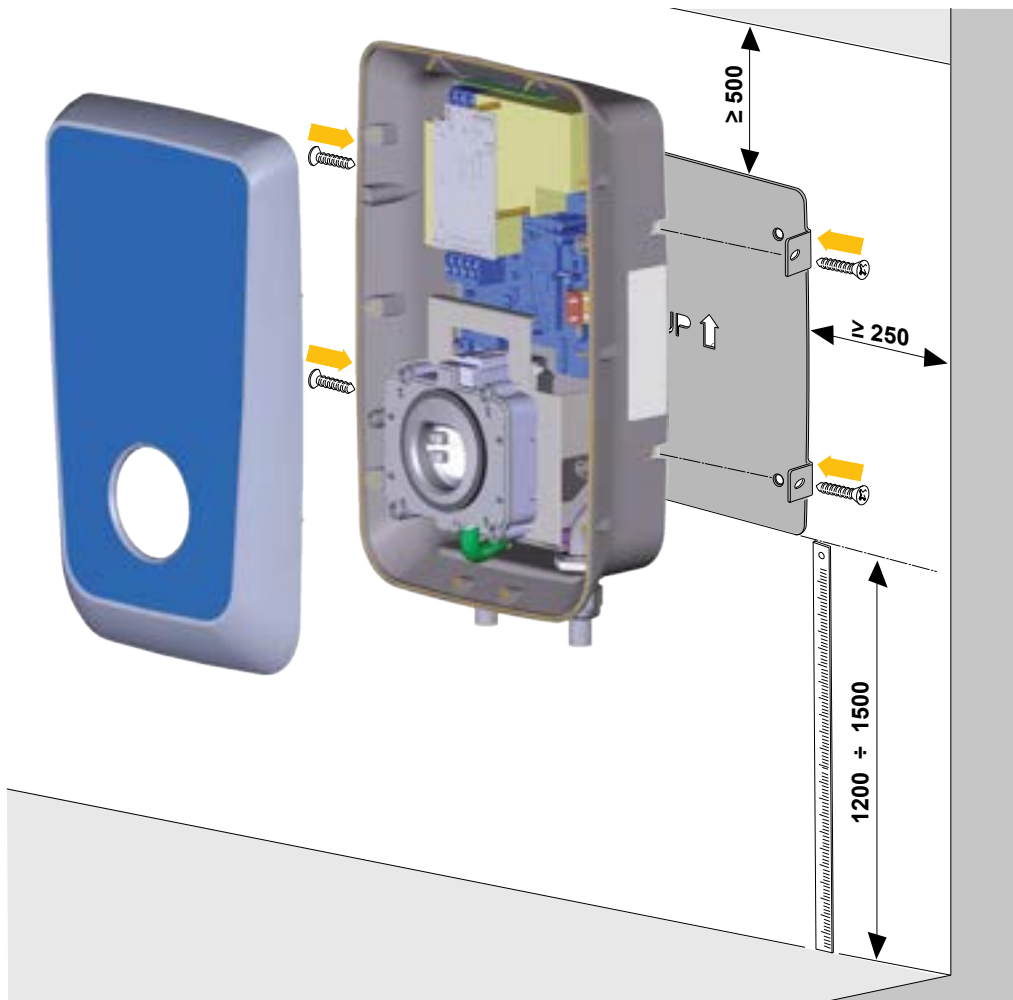

2. Use 4 screws $\varnothing 14 \times 40$ mm to secure the rear casing of the device to the fixing plate with a tightening torque of 1.7 Nm.

NOTE – Measurements are in mm.

3.8 Connection of power and earth cables

⚠ ATTENTION – During installation it is necessary to prevent the electrical connection of the power supply and to cordon off the entire work area, with only qualified and authorised personnel able to access it.

The equipment must be powered by cables that are properly dimensioned and capable of withstanding the current flow for which the product has been designed. Make sure that the cables are of suitable size before wiring and that the maximum permissible bending radii are not exceeded. The device's electrical data, which should be referred to in order to correctly size the power supply system, are displayed on the device's nameplate.

⚠ ATTENTION – The power supply to the appliance must remain switched off throughout this step.

⚠ ATTENTION – Failure to comply with these instructions can lead to serious damage to people and property, including death.

The images below are for illustrative purposes and may not show all the product's internal components.

The following diagram shows how to electrically connect the device in single-phase, two-phase and three-phase systems. In the case of a single-phase device connected to a single-phase power supply, the available LN pair replaces the quad L1-L2-L3-N visible in the diagram.

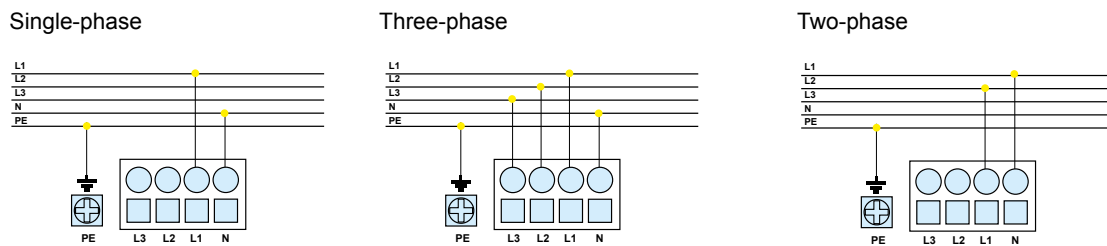

In case of multiple installations, it is recommended to foresee phase rotation:

Single-phase

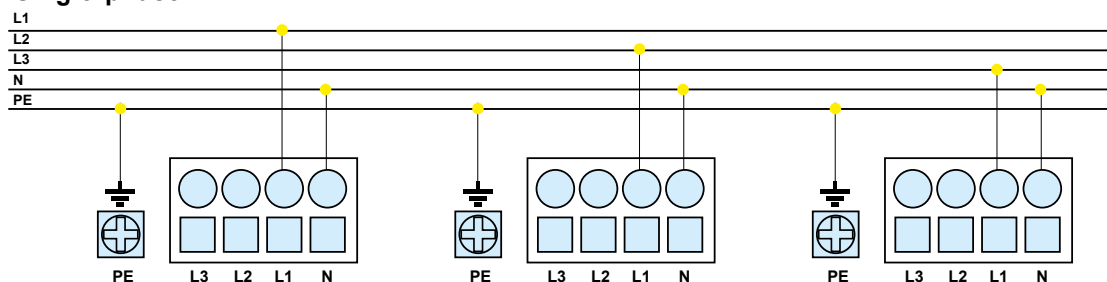

Three-phase

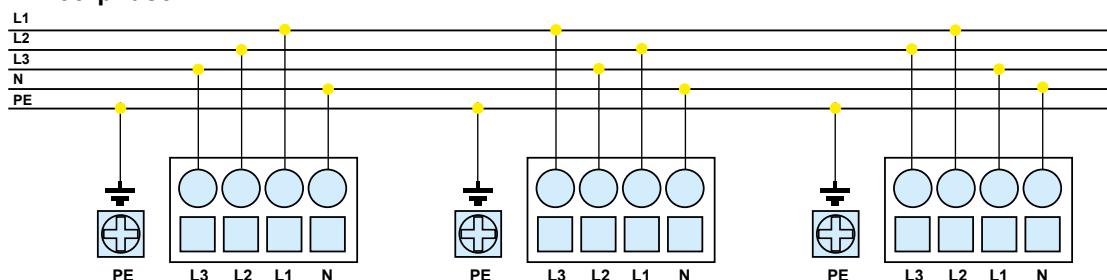

⚠ ATTENTION – In case of a M/S configuration, it is necessary to inform FIMER about the plant layout by providing the rotation of the phases to be implemented.

The following guidelines provide information on which power supply cables to use and the recommended conductor size:

- Multi-core cable outer diameter: 13-21 mm
- Recommended conductor size: 6-10 mm²
- Stripping length for power supply terminal block (L1-L2-L3-N): 18 mm
- Earth terminal: M5 eyelet terminals

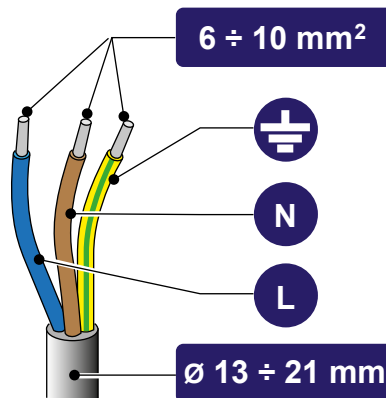

The following table shows the maximum conductor length in relation to chosen cross-section:







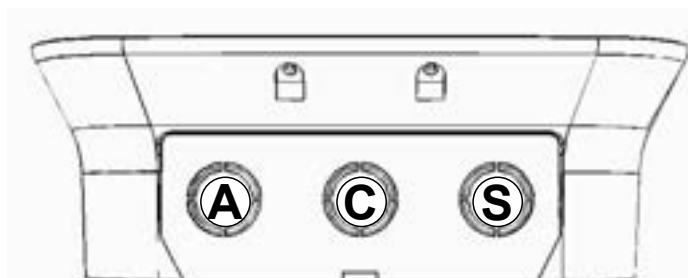

AC power Wallbox [kW]	In (A)	Cross section of conductor [mm ²]	Maximum length of conductor [m]
3.7	16	6	95
3.7	16	10	157
7.4	32	6	47
7.4	32	10	79
11	16	6	109
11	16	10	182
22	32	6	55
22	32	10	91

Once the device has been installed on the chosen wall, the following instructions must be followed to connect it electrically to the power supply:

The lower part of the casing has 3 cable inlets. The two side cable inlets will be closed off with a mushroom-shaped seal to prevent dust or moisture from entering during shipping.



The following table shows how they should be used for the input of power cables, communication ones and of the T2 cable, if any. The T2S and T3A versions will not use the center output (C), which will instead be occupied by the plug in the T2C version.

Cable inlets			
T2 Socket version			
T3A Socket version			
T2 Cable version			

A = Power supply
S = Communication cables
C = T2 Cable

The instructions for the versions with T2 or T3A sockets are given below, since in the case of the T2C version, the charging cable is already installed by the manufacturer, therefore no operations involving the “C” central hole are required.

1. Remove the mushroom-shaped seal from the left cable gland. Loosen the left cable gland and pass the multi-core cable through it. Pull the multi-core cable, leaving some slack inside the device (making sure that the length of the cables inside the unit is sufficient to reach the power and earth terminals located on the top left of the unit), then tighten the cable gland:



2. Power cable connection: strip the cables, then connect the phases and neutral to the power supply terminal block making sure that the entire stripped section of each cable is fully inserted into each terminal (stripping length 18 mm).

Earth cable connection: strip the cable and use M5 eyelet lugs to connect the earth cable to the earth terminal located to the left of the power supply terminals and tighten with a torque of 2 Nm.

The internal terminal block is as shown below:

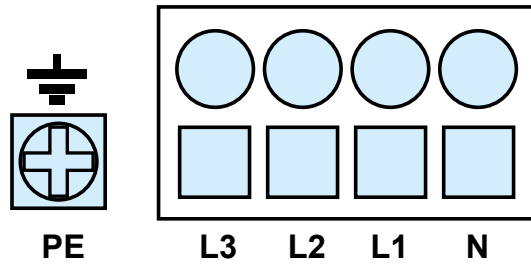

3.9 Residual-Current device management

To ensure compliance with the IEC 61851-1 standard, the installer must comply with some of the following requirements during the installation phase.

EXTERNAL PROTECTION

The product does not contain protective devices. It is only equipped with a 6 mA_{DC} continuous current detection device. Consequently, in accordance with the IEC 61851-1 standard, the device must be protected upstream by residual current devices and thermal-magnetic circuit breakers, which the installer must install externally.

Below is a table where you can check which types of circuit breaker to choose depending on the power of the device:

	Wallbox 3.7 kW	Wallbox 7.4 kW	Wallbox 11 kW	Wallbox 22 kW
Residual-current device	RCD 2P Type A 25 A 30 mA	RCD 2P Type A 40 A 30 mA	RCD 4P Type A 25 A 30 mA	RCD 4P Type A 40 A 30 mA
Thermal-magnetic circuit breakers	MCB 2P D20 10 kA	MCB 2P D40 10 kA	MCB 4P D20 10 kA	MCB 4P D40 10 kA

⚠ ATTENTION – Ensure that the rated voltage of the circuit breakers and residual current devices selected is compatible with the rated voltage of the charging device.

With regard to the external thermal-magnetic protection, the I_{2t} value of the chosen circuit breaker must not exceed 75000 A²s. The switch must comply with IEC 60947-2, IEC 60947-6-2 or IEC 61009-1 or the relevant parts of IEC 60898 or IEC 60269. As regards the external residual-current device, the chosen circuit breaker must comply with one of the following standards: IEC 61008-1, IEC 61009-1, IEC 60947-2 and IEC 62423.

NATIONAL RESTRICTIONS IN ITALY AND THE NETHERLANDS







All versions of the product (both SOCKET and CORD) are equipped with a normally open dry contact 3 A 250 V_{AC} (see Port Description), programmed to control a cut-off device in accordance with the IEC 61851-1 standard. The standard indicates that in Italy and the Netherlands, for the T2C and T3A versions of the product, in addition to the residual-current devices and thermal-magnetic circuit breakers, the installer must also compulsorily install an additional external device (by connecting it to the dry contact) capable of interrupting the power supply to the Wallbox when it goes into a specific fault state. The external devices to be used for this purpose could be motor controls coupled to the residual-current circuit breaker, trip coils or any other device compatible with that type of contact, as chosen by the installer.

⚠ ATTENTION – For the version with T2S (and in all other countries) the use of this additional device is not mandatory, but at the sole discretion of the installer.

INSTALLATION EXAMPLE

Example of arrangement of external MCB and RCD protections for a typical single-phase 3.7 kW and three-phase 22 kW installation.

RECOMMENDED DEVICES

Device	Wallbox 3.7 kW	Wallbox 22 kW
Thermal-magnetic circuit breaker (MCB)	<p>ABB S200 series S202M-D20</p> 	<p>ABB S200 series S204M-D40</p> 
Residual-current device (RCD)	<p>ABB F200 series F202 A-25/0,03</p> 	<p>ABB F200 series F204 A-40/0,03</p> 
Motorised actuator for residual-current circuit breaker	<p>ABB F2C-CM</p> 	
24V _{DC} power supply for actuator	<p>24 V_{DC} DIN Rail Power Supply</p>	
Surge protection device	<p>OVR T2 1N 40-275S P TS QS</p> 	<p>OVR T2 3N 40-275S P TS QS</p> 

CONNECTION DIAGRAM

The following picture shows an example of connection of electromechanical devices for a single-phase 3.7 kW Cord/T3A version installation.

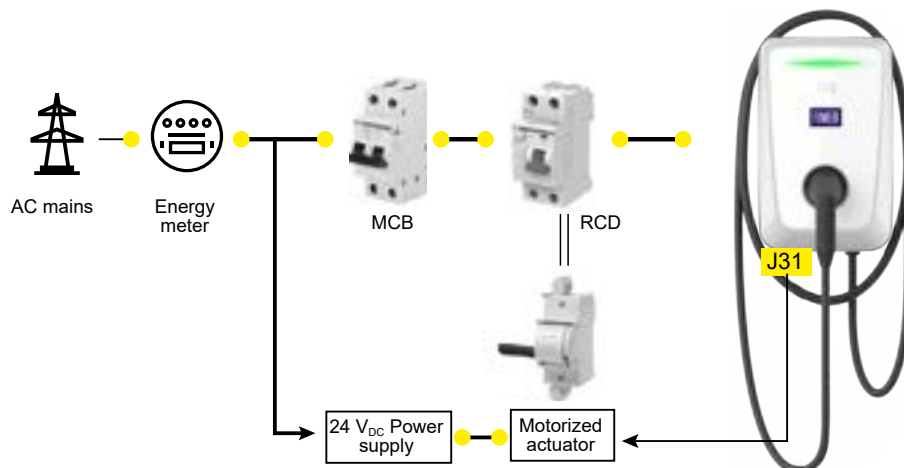

3.10 Communication cables connection

During installation, disable the electrical connection of the power supply and cordon off the entire working area, with access being permitted only to qualified and authorised personnel.

The power supply of the appliance must remain switched off throughout this phase. Failure to comply with these instructions can lead to serious damage to persons and property, including death.

The different versions of the FIMER FLEXA AC Wallbox are equipped with the following connectivity features:

FIMER FLEXA AC Wallbox	Stand Alone	Inverter Net	Future Net
RS-485 (x 2)	X	X	X
RFID	X	X	X
BLE	X	X	X
Contact for remote cut-off device	X	X	X
3G/4G			X
Ethernet			X
Wi-Fi			X

1. The communication cables must be inserted through the “S” cable gland. Before inserting any communication cables, the existing mushroom-shaped seal must be removed. If, however, no communication cables are to be used, the mushroom-shaped seal must not be removed.
2. Once the mushroom-shaped seal has been removed, the supplied “4-hole” gasket must be inserted into the cable gland to be used for routing communication cables. Make sure to use cables suitable for the hole cross-section (8 mm diameter) and such that the IP rating is guaranteed.

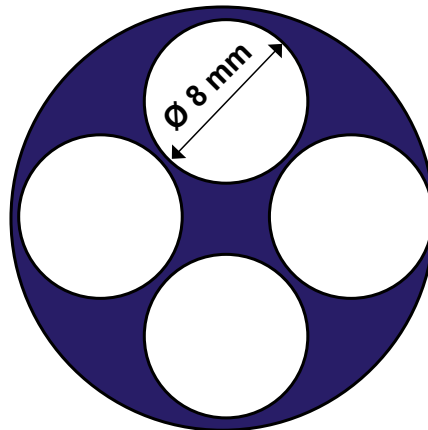

3. Once you have inserted the desired cable into one of the available holes, pull it to a length that reaches the part of the device where the communication port you want to use is located, leaving some slack. Repeat the operation for all the communication cables you wish to install
4. Holes that are not used must be closed using the white plugs provided to ensure the IP rating.
5. Tighten the cable gland
6. Insert the desired connectors into the chosen communication ports. For details of the available ports and their connection, please refer to the “Port Description” section.

3.11 Port description

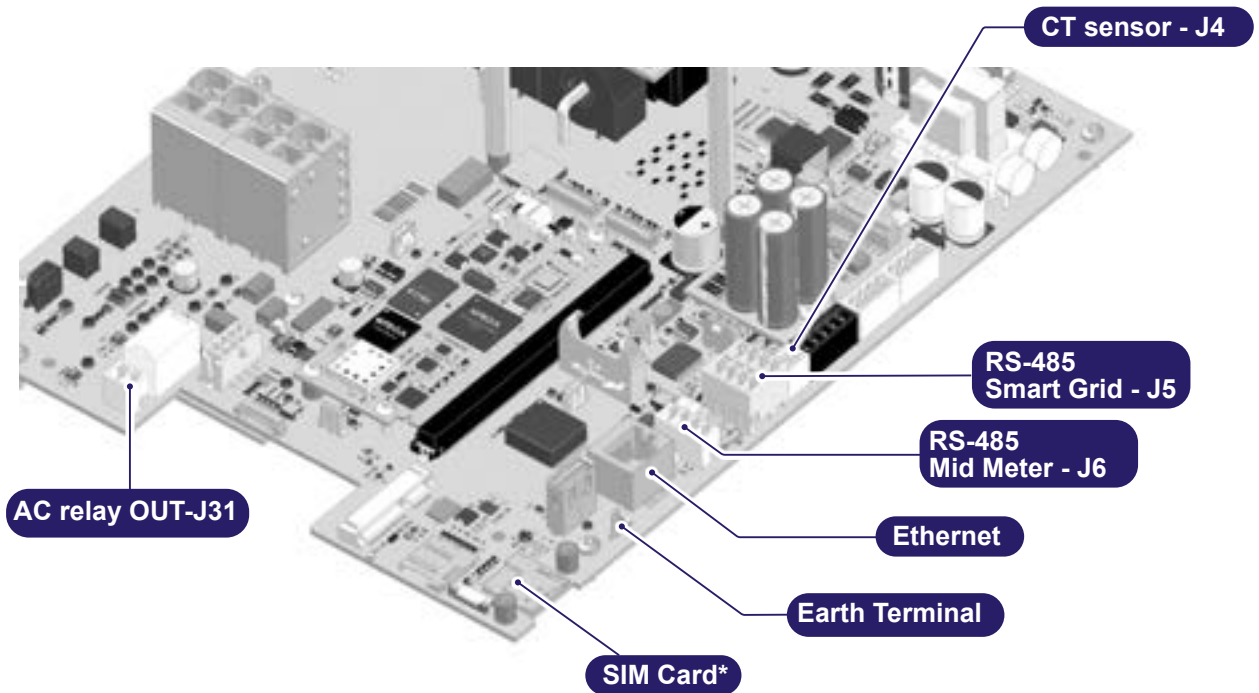

The following table summarises the ports available to the user:

Type	Port	Description	Stand Alone Inverter Net	Future Net
I/O	AC RELAY OUT-J31	Dry contact normally open relay output for AC charges up to 250 V _{AC} , 3 Amps current	1 x	
Communication	RS-485 SMART GRID-J5	RS-485 ModBus for Master-Slave communication or communication with REACT 2	1 x	
	RS-485 MID METER-J6	RS-485 ModBus for external MID meter	1 x	
	ETHERNET	Gigabit Ethernet	-	1 x
Others	SIM CARD	SIM card slot	-	1 x
	CT sensor - J4	Amperometric sensor for single-phase load management	1 x	1 x

NOTE – *SIM Card location may vary depending on the board version.

3.11.1 AC Relé OUT-J31

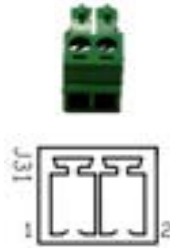
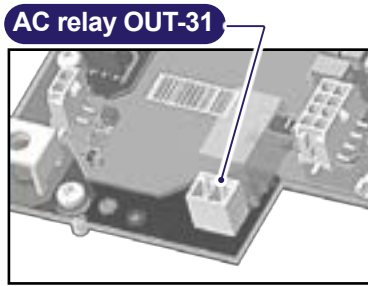

Type / Scheme of application
Non-isolated RS-485 communication port

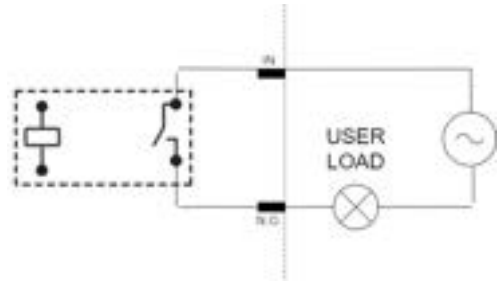

Features

Technology	Relay
Maximum voltage	250 V _{AC} / 30 V _{DC}
Maximum electrical current	3 Amps
Connector	PHOENIX CONTACT 1803426

Pinout

1	OUT1_IN
2	OUT1_NO

3.11.2 CT Sensor – J4

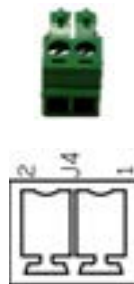
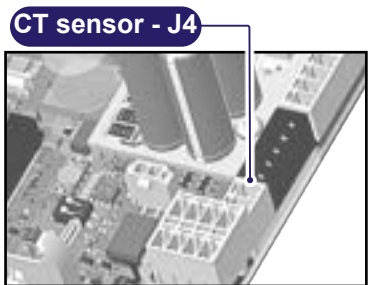

Type / Scheme of application
Amperometric sensor for single-phase load management

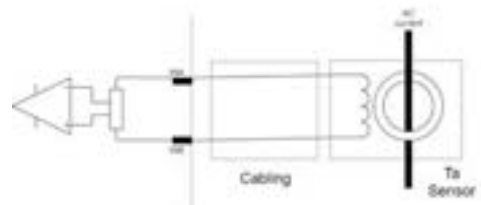

Features

Connector	PHOENIX CONTACT 1803426
-----------	-------------------------

3.11.3 Gigabit Ethernet

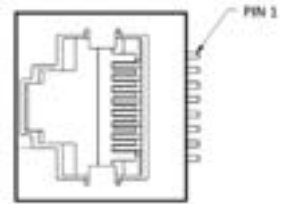
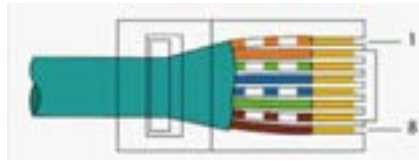
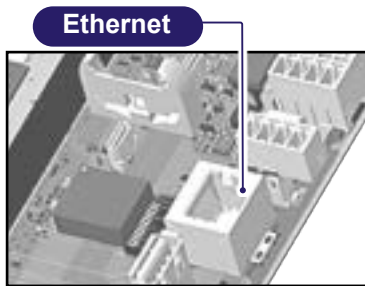

Features	
Type	10BASE-T, 100BASE-TX (Fast Ethernet), 1000BASE-T (Gigabit)
Cable requirements	CAT6 or higher (with CAT6 cables, the speed may be limited in Gigabit applications)
Cable shielding	SF/UTP: Shielding with metal braiding on total cable assembly, no shielding on individual cable pairs SF/FTP: Double-shielded with metal braiding on the cable assembly and individual pairs individually shielded (preferable).
Socket type	RJ45 with metal shielding
Maximum connection length	Maximum 100 meters
Earthing shielding	Proper earthing requires connecting the shield of the Ethernet cable to the earth on both sides. This is done by using shielded cables with shielded metal RJ45 plugs.

3.11.4 RS-485 Smart Grid-J5

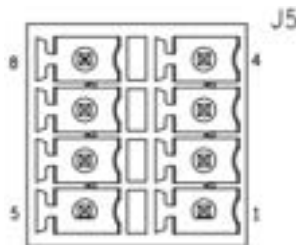
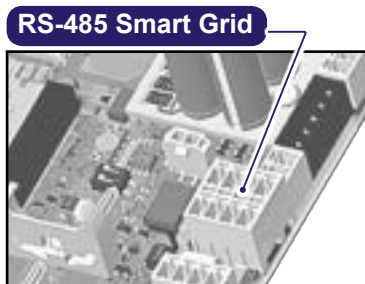

Type / Scheme of application
Non-isolated RS-485 communication port

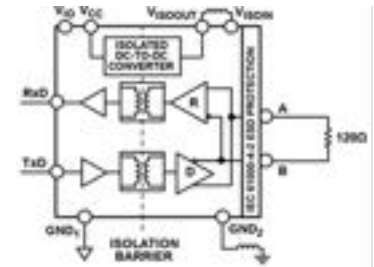

Features	
Insulation	3 kV RMS
Termination	120 Ω (integrated and selectable)
Protocol	ModBus
Connector	PHOENIX CONTACT 1952995
Counterpart	PHOENIX CONTACT 1952283

Pinout	
1	Data negative
2	Data positive
3	RTN – Signal Ground
4	SHIELD – Bus Cable Shield
5	Data negative
6	Data positive
7	RTN – Signal Ground
8	SHIELD – Bus Cable Shield

BUS TERMINATION

Bus termination is required to prevent signal reflections at the Bus end. The Bus must be terminated with $120\ \Omega$ at both ends (i.e., near the first and last node of the chain).

Alternatively, the termination resistor can also be set via MyFIMERwallbox App, and in the case of a Future Net, it will be necessary to switch the Wallbox to Stand Alone-like mode before activating it.

⚠ ATTENTION – It is recommended to use the procedure involving the physical insertion of a terminating resistor.

DAISY CHAIN CONNECTION

This RS-485 communication port exposes a connector that makes a Daisy Chain connection possible.

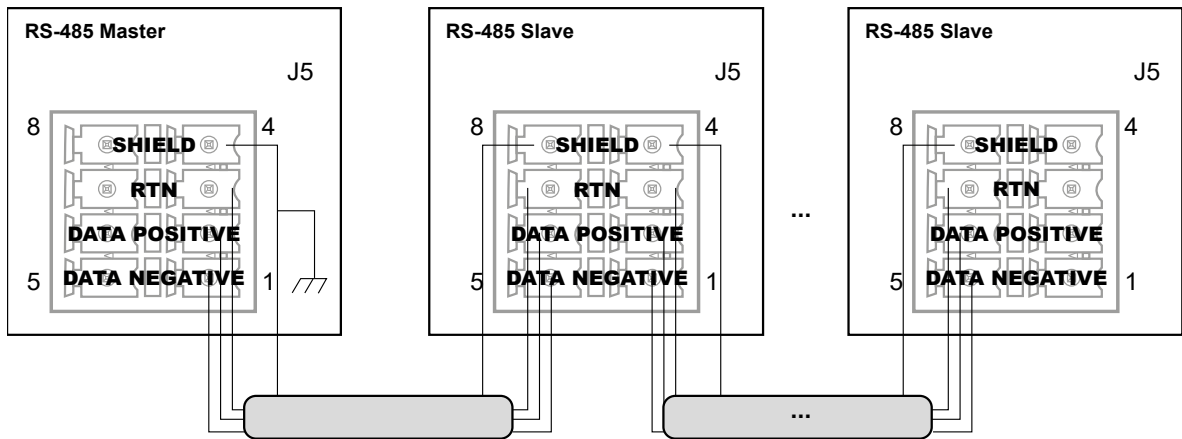

It is important that the communication cable SHIELD is referred to PE at a single point, at the first node of the Daisy Chain. For all subsequent connections, the metallic continuity of the cable is ensured by the connection point called SHIELD on the connector.

If there is a serial connection of several devices, it is necessary to set the serial node address by using the Dip Switches on the Wallbox board so that each device has a different address.

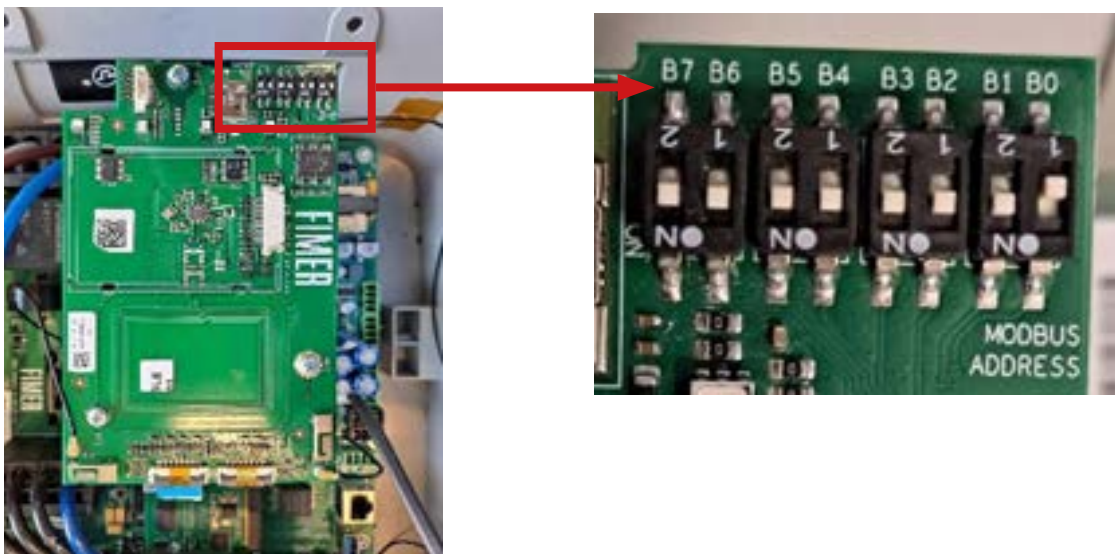

By default, address 1 is applied (as pictured above).

To change the serial address of the Wallbox Stand Alone, simply change the status (up or down) of the switches as shown in the table below.

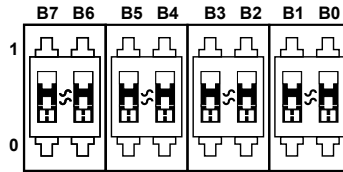

Device ID								
	B7	B6	B5	B4	B3	B2	B1	B0
1								
2								
3								
...
247								

Connection requirement:

Cable type	AWG	Characteristic impedance	Operating voltage	Operating temperature
Shielded	22 - 24	120 Ω	≥300 V	-20 ... +60 °C

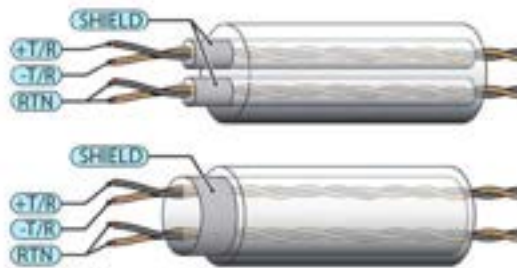

⚠ ATTENTION – The metallic continuity of the shielding must be guaranteed along the communication line, which must be grounded at a single point. It is recommended not to exceed a length of 1000 m for the communication line.

3.11.5 RS-485 Mid Meter-J6

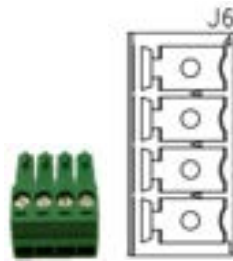
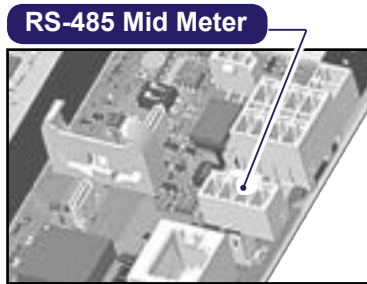

Type / Scheme of application
Non-isolated RS-485 communication port

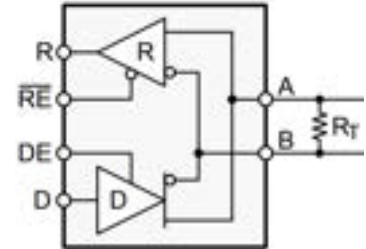

Features

Termination	120 Ω (integrated)
Protocol	ModBus
Connector	PHOENIX CONTACT 1843622

Pinout

1	Data negative
2	Data positive
3	RTN – Signal Ground
4	SHIELD – Bus Cable Shield

BUS TERMINATION

Bus termination is required to prevent signal reflections at the bus ends. The Bus must be terminated with 120 Ω at both ends (i.e. near the first and last node of the chain). The Bus is terminated on the Wallbox side by a 120 Ω resistor.

Cable type	AWG	Characteristic impedance	Operating voltage	Operating temperature
Shielded	22 - 24	120 Ω	≥300 V	-20 ... +60 °C

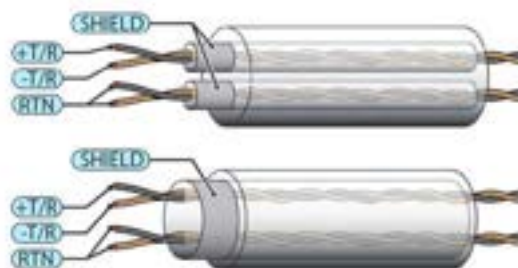

⚠ ATTENTION – The metallic continuity of the shielding must be guaranteed along the communication line, which must be grounded at a single point. It is recommended not to exceed a length of 1000 m for the communication line.

3.12 Dynamic Power Management

Dynamic Power Management or DPM is a function that adjusts the charging power according to the available power. The DPM function is available in all models and versions and requires an external meter.

Version	kW	Compatible Meters
Single-phase	3.7	CT sensor (included)
	7.4	Gavazzi EM111 ABB 21 111-100
Three-phase	11	Gavazzi EM340-DIN.AV2.3.X.S1.PF.A.70
	22	ABB B23 212-100

DPM setting via “MyFIMERwallbox” App:

- Select the compatible meter in the “Meter” section
- Enable DPM
- Set contractual current limit in the “DPM limit” section

3.12.1 CT sensor installation

To use the Dynamic Power Management function, a sensor must be installed downstream of the electricity meter. Based on the current measured by the sensor, the Wallbox calculates the energy absorbed by the user and modulates the charging current of the electric vehicle in order to avoid blackouts.

The connection diagram is shown in the figure.

ELECTRICAL SCHEME:

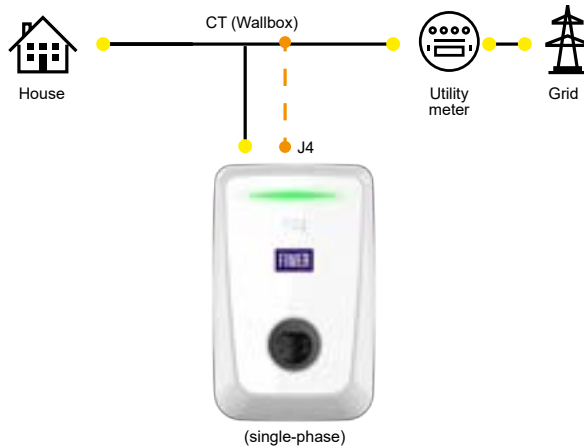

CONNECTION REQUIREMENTS

- The sensor is supplied pre-wired with 1.5 meters of braided wire.
- Extend as necessary; the maximum recommended length is 150 m.
- Connect to the Wallbox using the counterpart supplied. There is no polarity requirement in the connection.
- Use twisted and shielded bipolar cable, AWG 26 wire, UL1007 (or equivalent).
- Route the connection cable between the sensor and the Wallbox away from power cables and other potential sources of interference.

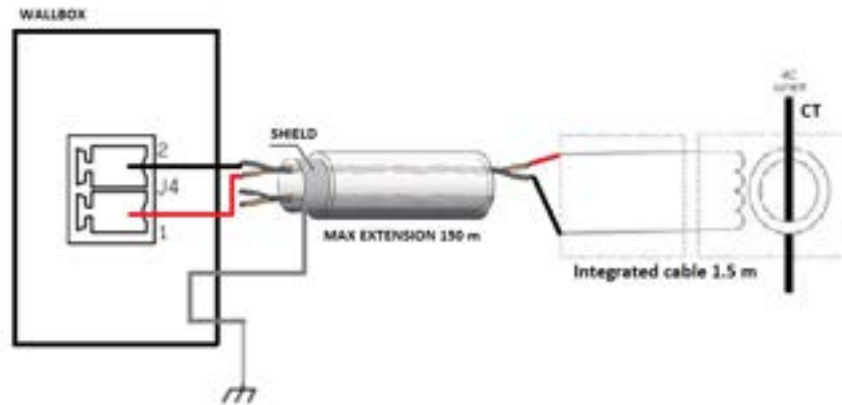

ATTENTION – The CT sensor must be installed by a qualified professional technician in accordance with local regulations.

3.12.2 External meter installation

ATTENTION – To use dynamic power management function, the installation of a compatible meter downstream of the electric utility meter is required. Based on the current measured by the meter, our Wallbox calculates the energy absorbed by the house and modulates the electric vehicle charging current to avoid blackouts.

The connection diagram is shown in the figure.

ELECTRICAL SCHEME:

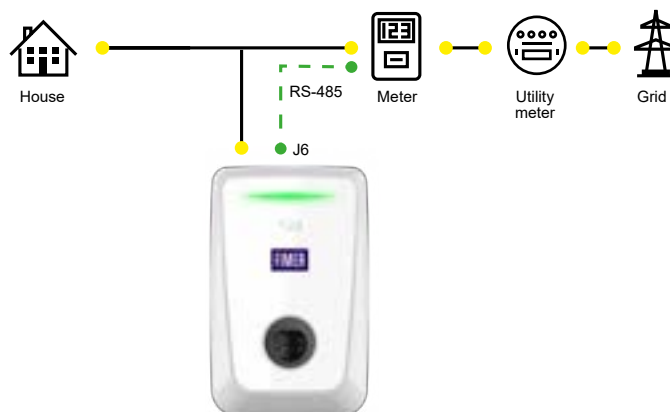

Connection diagram to the meter is the same for both single-phase meter and three-phase meter.

Parameter	Value
Protocol	ModBus
BAUD	9600
Parity	None
Address	1 (is the ModBus address of the Wallbox, set via dipswitch)

Connect the J6 connector (Phoenix green 4-pin) of the Wallbox to the RS-485 connector of the meter according to the diagram in figure.

NOTE – For distances greater than 1 m the A and B conductors are preferably AWG26 or larger, twisted and shielded.

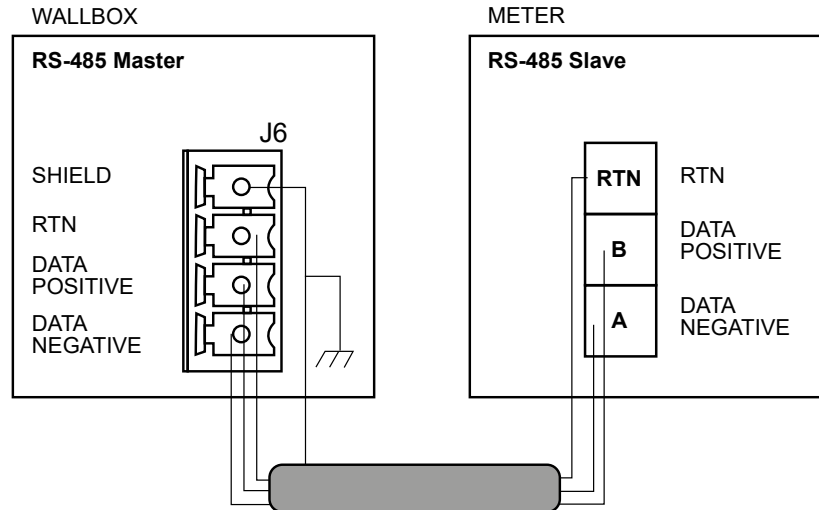

Figure: RS-485 bus connection diagram between Wallbox and compatible meters.

Via App or tool enable DPM and select the installed Meter.

NOTE – Check that the wiring of ModBus communication with the meter has been done correctly before activating the DPM functionality.

CONNECTION REQUIREMENTS

The supplied sensor comes pre-wired with 1.5 meters of braided wire.

- Extend as needed; the maximum recommended length is 150 meters.
- Connect the Wallbox using the supplied counterpart. There is no requirement for polarity in the connection.
- Use braided and shielded two-core cable, AWG 26 wire, UL1007 (or equivalent).
- Arrange the connecting cable between the sensor and Wallbox in a position not adjacent to power cables and other potential sources of disturbance.

NOTE – Installation of the meter must be carried out by a licensed professional installer according to local regulations.

3.12.3 FLEXA AC Wallbox Inverter Net and REACT 2 integration

Thanks to the integration between FLEXA AC Wallbox Inverter Net and REACT 2, in domestic applications, all energy flows, including EV charging, can be monitored and managed in the most convenient way. The two devices share data via RS-485 connection.

The preliminary requirements for integration are:

- FIMER REACT 2 must be correctly installed and commissioned. It should have a firmware version greater than or equal to 1.0.5 (update if lower, as described in the product manual).
- FIMER FLEXA AC Wallbox must be correctly installed and commissioned.

Electrical scheme:

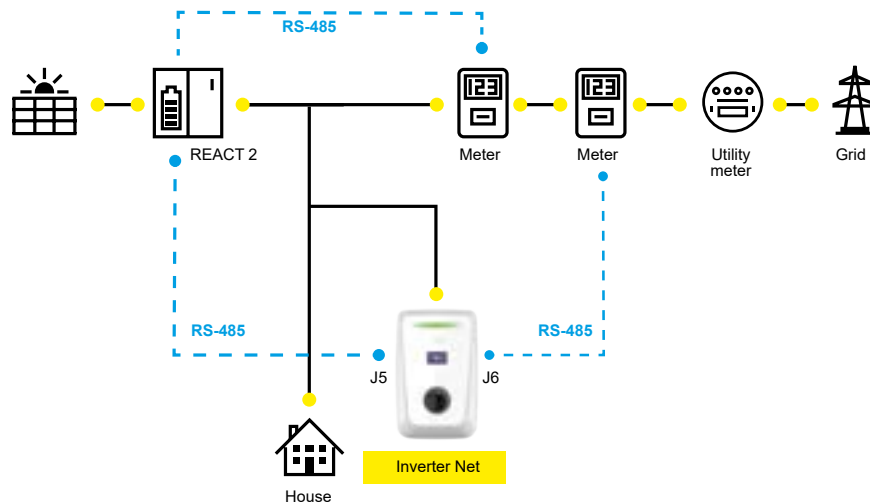

NOTE – Compatible meter must be used.

ATTENTION – This configuration is not compatible with CT sensor.

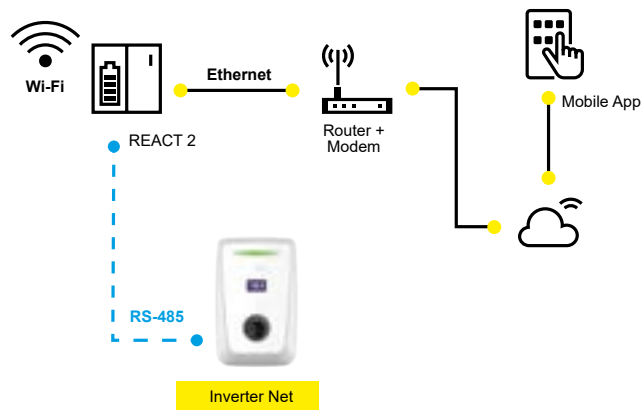

FLEXA AC Wallbox and FIMER REACT 2 share data via RS-485 Bus. Connect the RS-485 pins as shown below. Make sure to set line termination switch 37 to position “ON”.

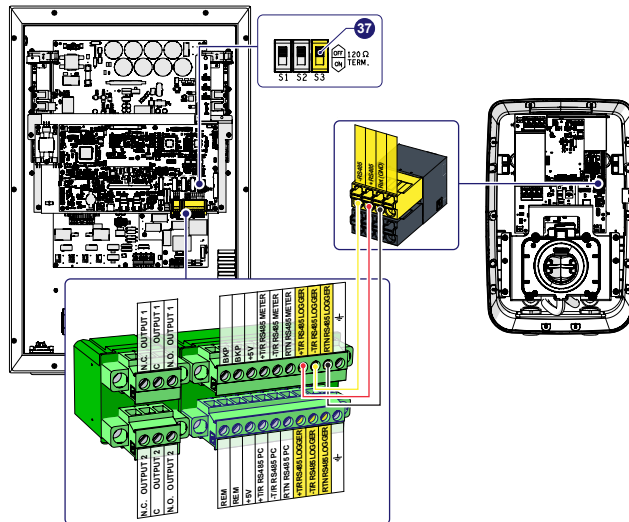

PAIRING:

- Access the FIMER REACT 2 webservice user interface
- Access as “Administrator”
- Click on “Connectivity” icon (1), ModBus menu (2) and edit RS-485 (3)





- Set the proper RS-485 port settings (11520 bps, No Parity, Device acquisition) and click on “Save” (4)
- Wait for the inverter to reboot
- Select “FLEXA AC Wallbox” (5) and click on “Add” (6)

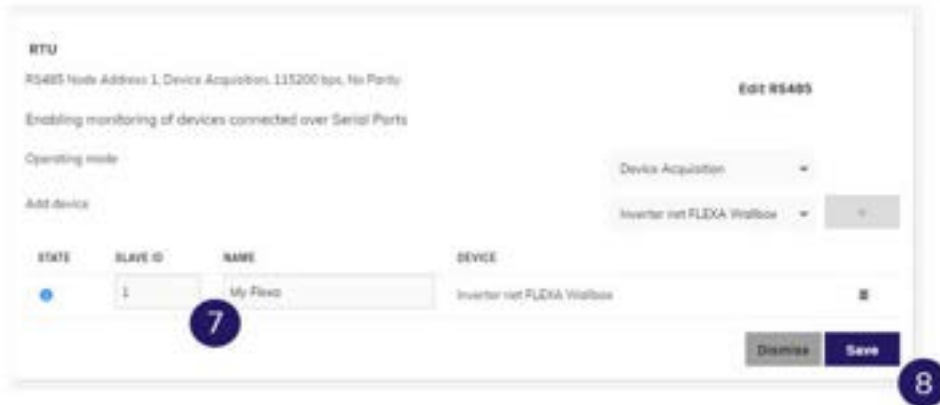

- Insert a name for the Wallbox and 1 as “Slave ID” (7)
- Click on “Save” (8)



Stato	Descrizione
	
	REACT2 and FLEXA are communicating properly
	Communication time out. REACT2 and FLEXA don't communicate. Check the RS-485 Bus and RS-485 port settings

3.12.4 FLEXA AC Wallbox integration with solar inverters

To allow the correct operation of the Wallbox even with an already installed inverter, it will be necessary to use one of our compatible bidirectional meters that will be installed as in the electrical scheme below.

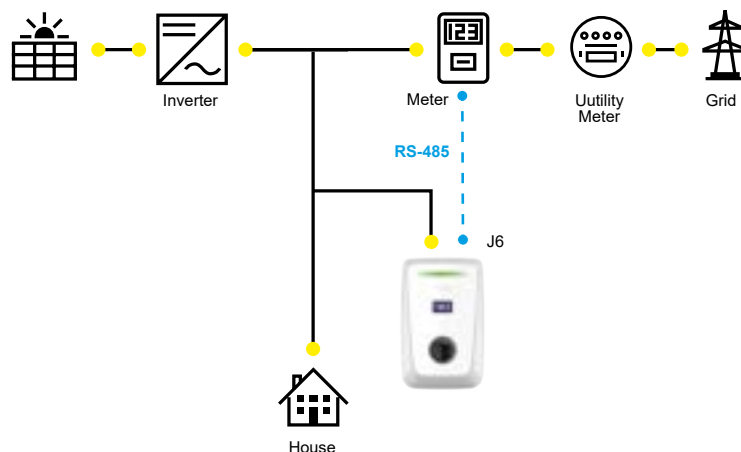

For information on the settings to be implemented in the Meter and Wallbox for proper operation in this configuration, refer to the chapter dedicated to the external meter installation.

3.13 Closing operations and power supply

- ⚠ ATTENTION** – During installation it is necessary to disable the electrical connection of the power supply and to cordon off the entire working area, which only qualified and authorised personnel should be able to access.
- ⚠ ATTENTION** – The equipment can only be powered up once this step has been completed.
- ⚠ ATTENTION** – Failure to comply with these instructions can lead to serious damage to persons and property, including death.

1. Place the front cover on the casing of the product.
2. Check the correct connection of the power supply (L1-L2-L3-N-PE), making sure that the respective positions of the phases and neutral in the main connector respect the markings and that the earth protection is correctly connected to its dedicated terminal.
3. Using the 10 40x14 screws initially removed during unpacking, secure the front cover to the rear body of the device with a tightening torque of 1.8 Nm. If there is insufficient space for screwing in, use a screwdriver with a shorter length.

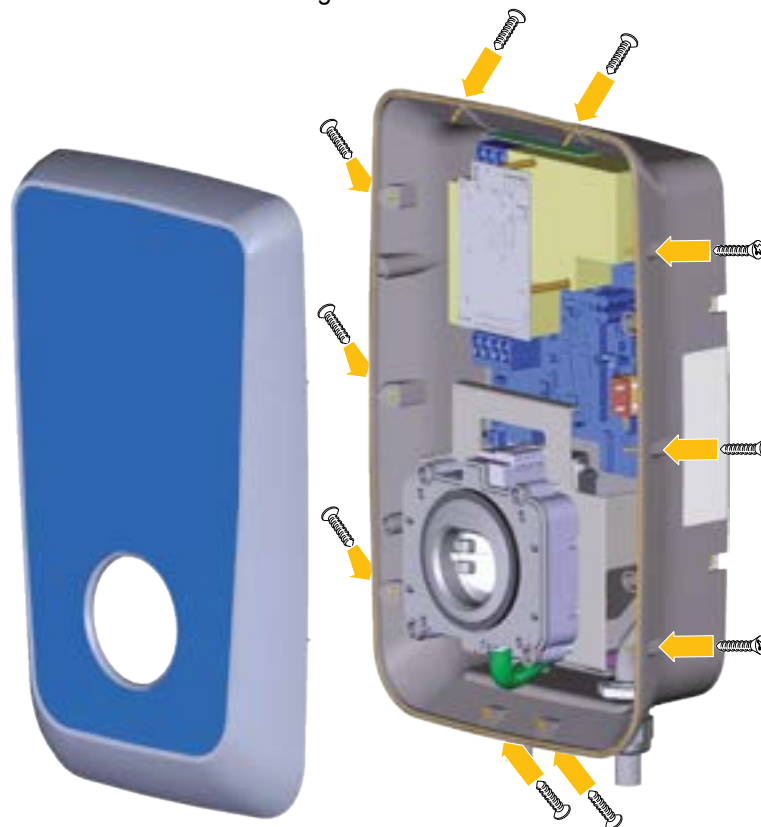

4. Once the device is closed, it can be powered by enabling the upstream power system.
5. Once powered up, the device performs a test cycle before switching to “Ready to charge” state, characterized by a steady green LED light.

4. First start-up and configuration

4

- ⚠ **ATTENTION** – FIMER products are configured in the factory before delivery in accordance with the information provided by the customer.
- ⚠ **ATTENTION** – All customers or users are required to provide, at the time of purchase, information about the required configuration and the electrical characteristics of the network to which the station will be connected.
- ⚠ **ATTENTION** – FIMER considers the information provided at the time of purchase to be definitive and, consequently, any changes in configuration or any other necessary activity that was not agreed or defined at the time of purchase will not be included in the warranty.

For all these reasons, once the above procedure has been carefully completed by a qualified technician, the device can be considered ready for first use.





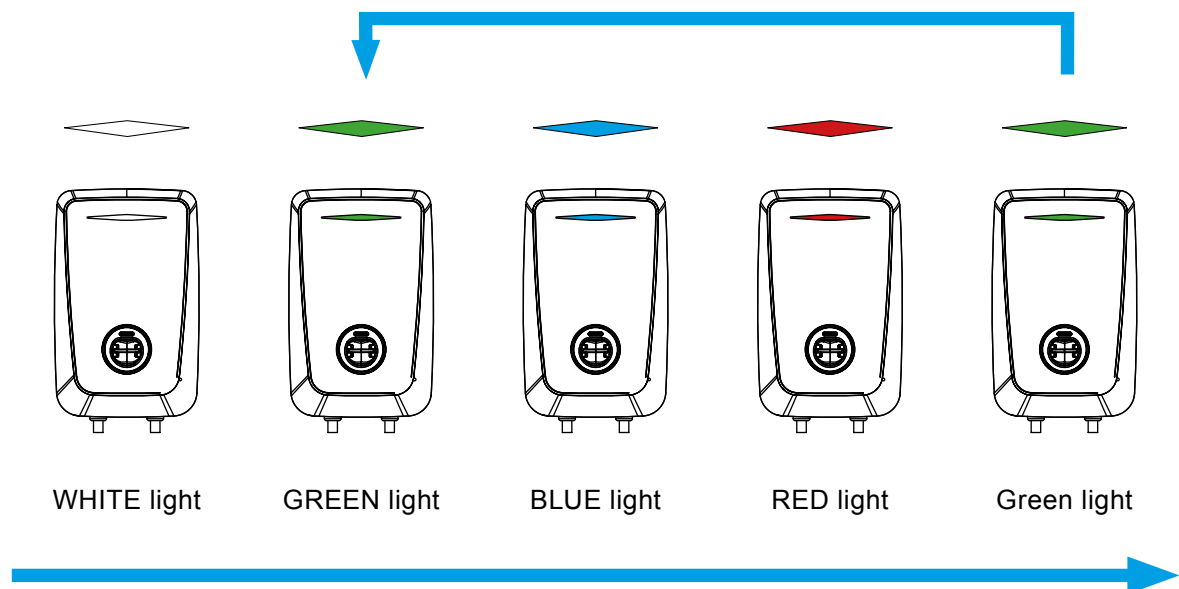







4.1 LED behavior

When the device is switched on (start-up), the LED carries out the sequence described below for approximately 10 seconds:



4.2 LED behavior during operation

Once the start cycle is completed, the LED can display the following colors.

LED	State	Description	Stand Alone Inverter Net	Future Net
	Steady green light	Ready to charge	•	•
	Steady blue light	Closed relays. Vehicle not charging (EV current consumption below minimum threshold).	•	•
	Pulsating blue light	Closed relays. EV in charge.	•	•
	Steady red light	AC input failure (Mains power not present and backup power enabled)	•	•
	Flashing red light	Error	•	•
	Flashing pink light	FW upgrade	•	•
	Flashing blue/green light	Waiting for card (Internal RFID White List)/waiting for card (OCPP)	•	•
	Flashing green/purple light	Waiting for card validation from OCPP		•
	Flashing green/yellow light	End of OCPP charging transition		•
	Flashing green light	Pre-authorization from App or terminal	•	
	White flash	Valid RFID card	•	•
	Red flash	Invalid RFID card	•	•

NOTE – If a Stand Alone Wallbox is connected to a Future Net in M/S the LEDs will follow the behavior of the Master.

5. *Operating instructions*

5

⚠ ATTENTION – The images below are for illustrative purposes and may not show all internal components installed in the product.

5.1 Preliminary charging operations

⚠ ATTENTION – During the entire charging process, DO NOT remove the charging connector from the electric vehicle. Only remove the charging connector from the vehicle when charging operations have ended or have been interrupted following the appropriate procedure. Removing the charging connector from the vehicle during the charging process can cause serious damage to property or persons.

Before starting a new charging session:

⚠ ATTENTION – Ensure that the product and its connectors are perfectly intact, dry and free of any impurities

⚠ ATTENTION – Do not insert fingers or objects into the socket

⚠ ATTENTION – Make sure that the product is not and has not been exposed to heat sources or explosive or flammable substances

⚠ ATTENTION – Ensure that the electric vehicle is compatible with the product's technical characteristics

⚠ ATTENTION – Do not use adapters or extensions not specified by the manufacturer as they may damage the product and create safety hazards for the user.

⚠ ATTENTION – Vehicle adapters must not be used to attach a connector to a vehicle socket

⚠ ATTENTION – Adapters between vehicle socket and plug should only be used if specifically designated and approved by the vehicle manufacturer or the manufacturer of the electric vehicle's power supply equipment, in accordance with national requirements. Such adapters must, however, comply with the requirements of the IEC 61851-1 standard and other relevant standards governing both the plug and socket of the adapter. The adapters must in any case be marked with specific indications for use permitted by the manufacturer (e.g. IEC 62196)

5.2 Charging operations

FIMER FLEXA AC Wallbox allows the EV to be charged in the following ways:

- **Open Access:** The Wallbox requires no authorization to start charging, just connect the cable to the EV and it starts automatically.
- **Remote Authorization:** it happens when the Wallbox is connected to an external terminal that enables starting the charging session via ModBus RS485. This is the case, for example, of our FIMER e4self solution, in which the Wallbox is connected to a payment terminal (e-smartOPT) that manages all connected devices and charging payments.
- **Local RFID Authentication:** in this operating mode, charging is activated by passing an RFID card registered to a permanent local “white-list” in the Wallbox memory.
- **Authentication via service center:** this operating mode is present in Future Net model only, where charging is enabled via RFID card connected to a backend or remotely via backend App. The Wallbox communicates with service center via OCPP 1.6 Json protocol.

Charging operation	Stand Alone	Inverter Net	Future Net
Open Access	•	•	•*
Remote authentication	•		
Local RFID	•	•	•*
Authentication via service center			•

* The Future Net works in this way only in case it is set to Stand Alone mode via App.

5.2.1 Open access

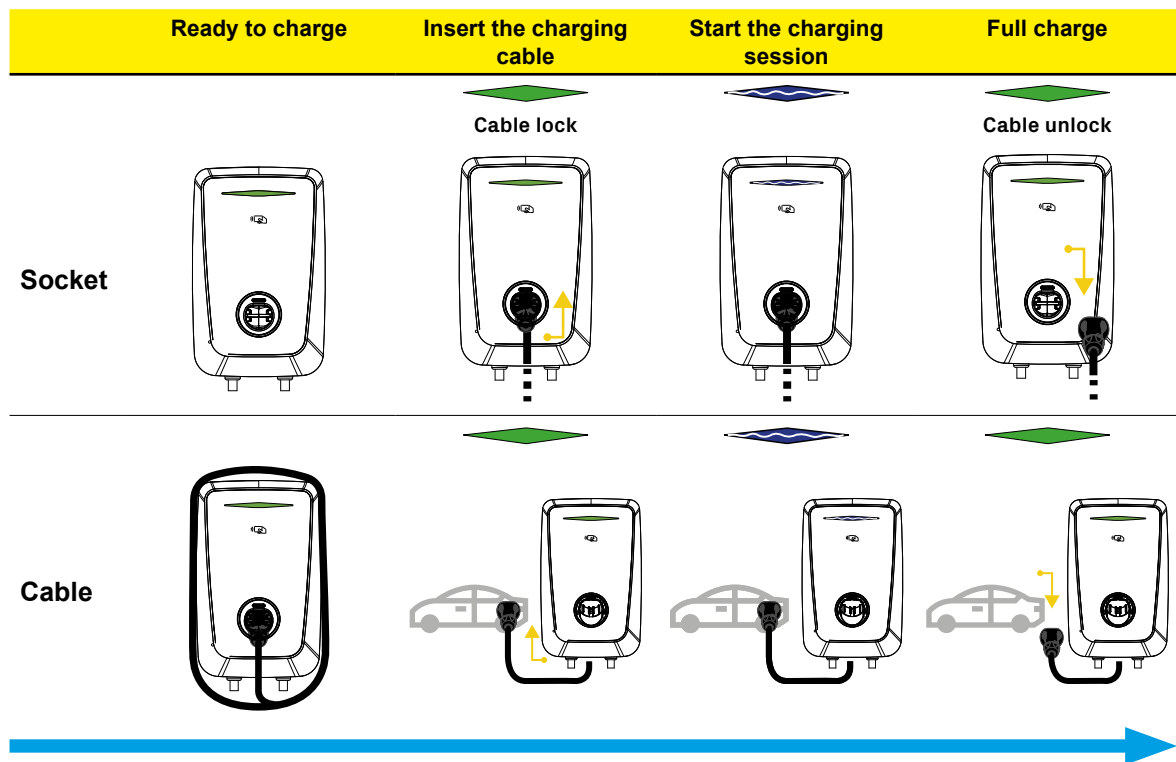

NOTE – If you want to end the session before the EV is fully charged, you need to stop the charging from the terminal or the EV itself.

5.2.2 Remote authentication

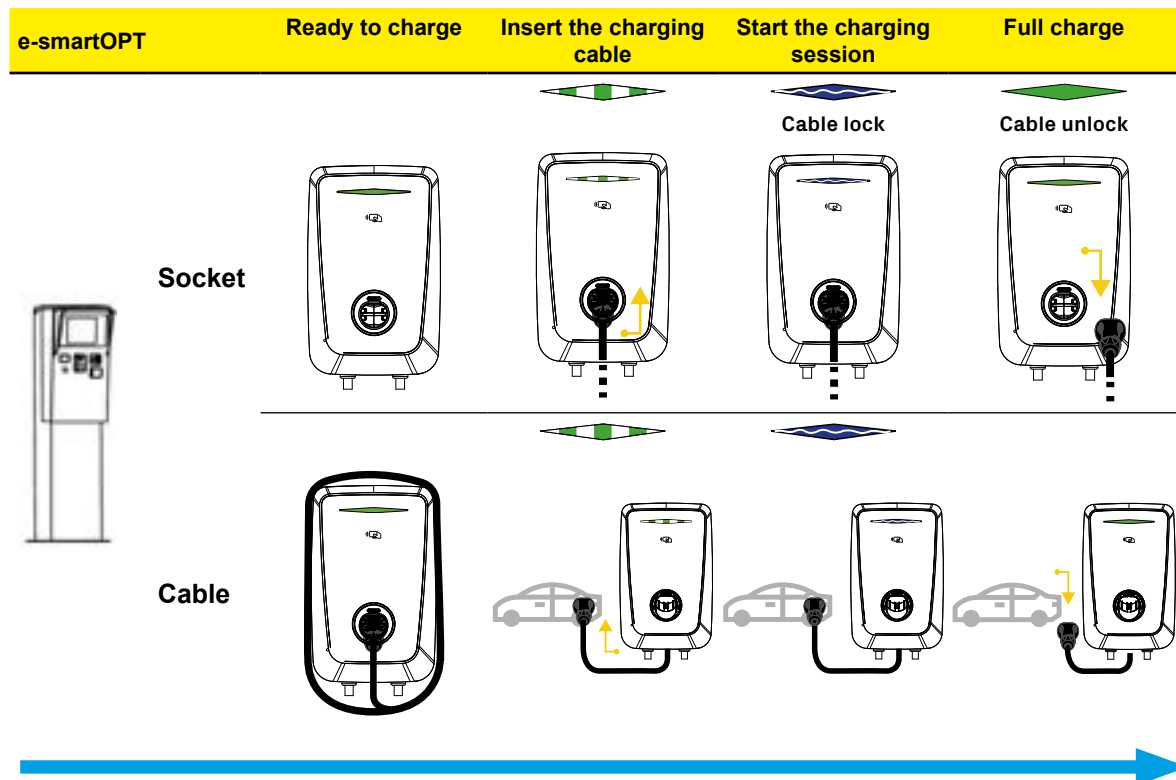

NOTE – The terminal will need to be used to activate charging. In case the Wallbox has already been booked via App, it will have a steady yellow LED.

5.2.3 Local RFID

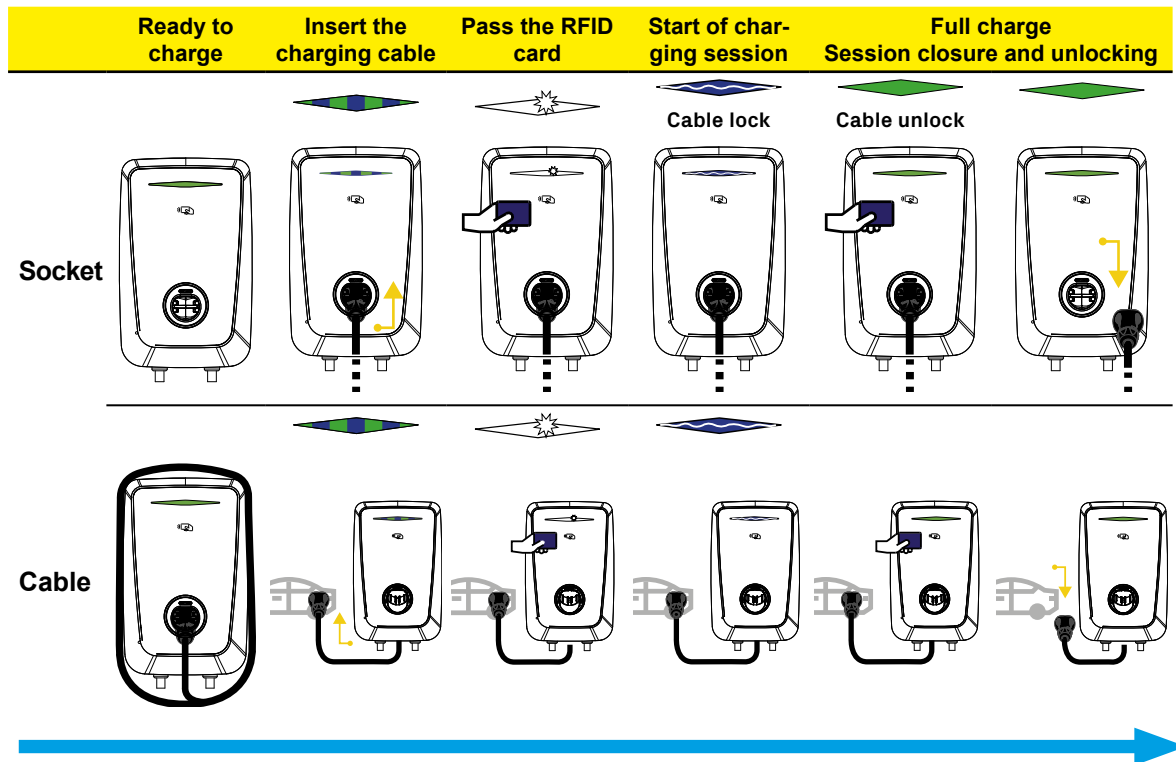

NOTE – To interrupt the session before the EV is fully charged, swipe the RFID card again the LED will turn Green/yellow flashing waiting for the EV to disconnect. Alternatively, you can do this from the EV itself and then you need to swipe the card to unlock the Wallbox side cable in the socket version.

5.2.4 Authentication via service center

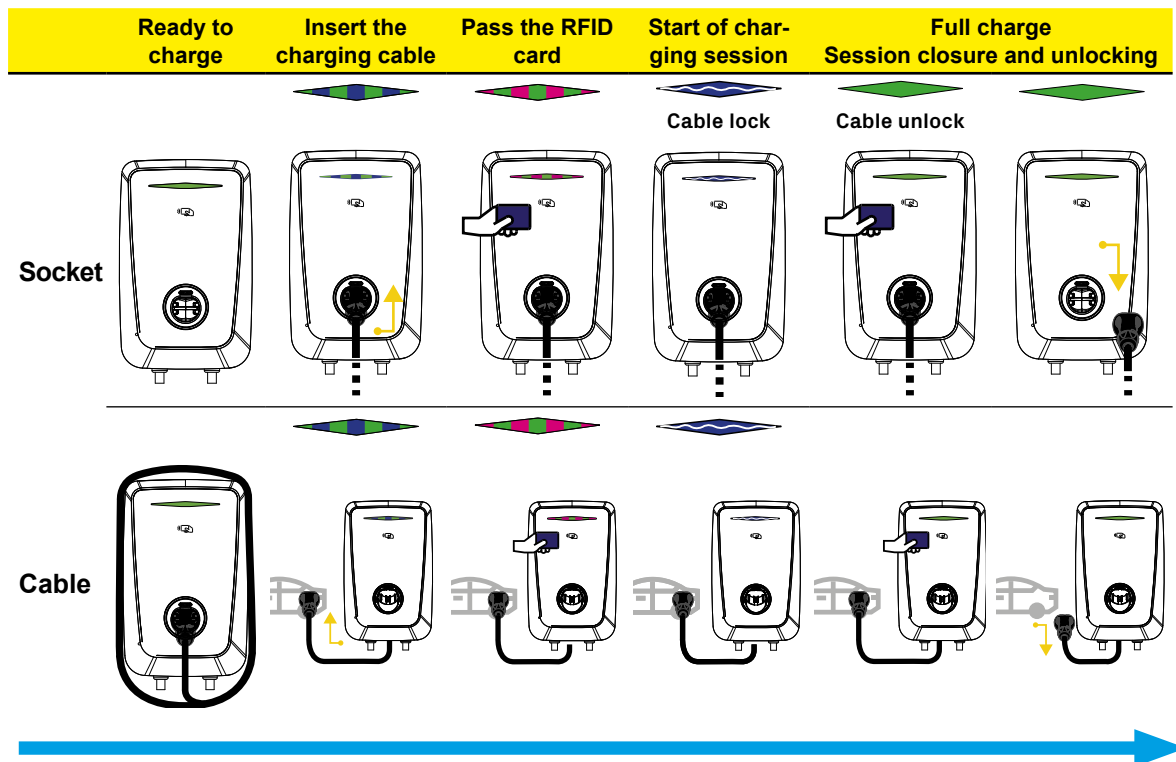

NOTE – To stop the session before the EV is fully charged, swipe the RFID card again either from the App or from the EV and, if necessary, swipe the card again to unlock the cable.

5.3 RFID card operations

To enable charging via RFID cards, it is necessary to have the MASTER RFID card (red in color) supplied with the product. The Wallbox has a “White List” inside where users can register, enabling vehicle charging.

The transition between operations is done sequentially:

- Starting from the Wallbox with the LED steady green (“Normal operation”) switch the MASTER card, by doing so the LED will turn flashing green (“Registration”),
- Pass the SLAVE card (blue in color) that you intend to register, the Wallbox will emit a sound and a white flash,
- Pass the MASTER card, the LED will become white flashing (“Verification”),
- Pass the SLAVE card, the Wallbox will emit a sound and a white flash,
- Pass the MASTER card, the LED will turn yellow flashing (“Cancel”),
- Pass the MASTER card again, the LED will turn steady green again (“Normal operation.”).

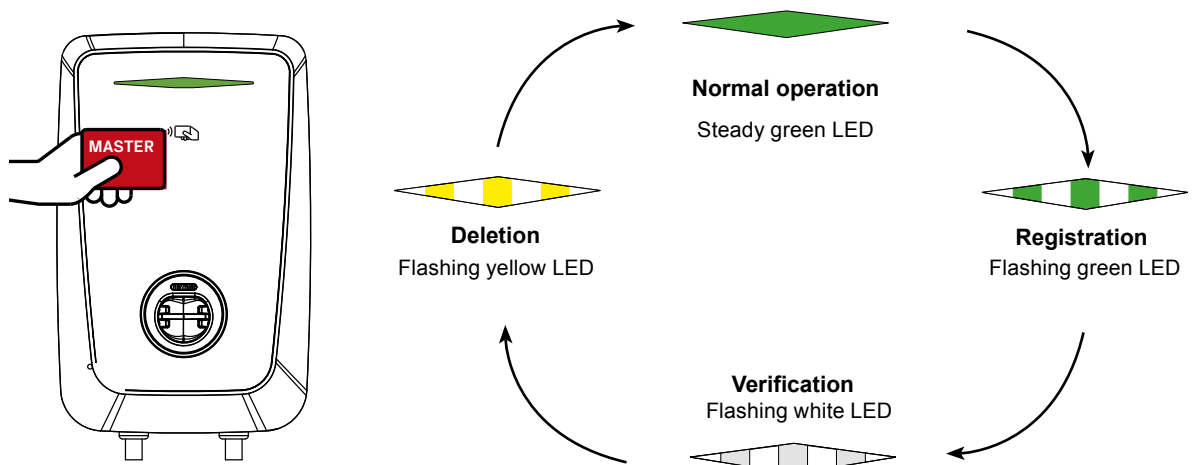

⚠ ATTENTION – In case no RFID card is swiped, the system will return to the normal operation state after 60 seconds.

5.4 MyFIMERwallbox App

Our 'MyFIMERwallbox' App is designed to display and manage FLEXA AC Wallbox parameters via Bluetooth when not connected to a service center.

The App is available in Italian and English, compatible with, iOS 12, Android 6 and newer operating systems.

MyFIMERwallbox is available on Apple Store and Google Play Store.

5.4.1 FLEXA AC Wallbox pairing

- ⚠ ATTENTION** – To pair your Wallbox with the App, you need to scan a QR code with your camera.
- ⚠ ATTENTION** – The QR code is placed on a removable label that can be removed and stuck into this manual so that it can be kept for future authorisations of other devices.
- ⚠ ATTENTION** – Since QR code contains privileged information that allows the App to securely and confidentially connect with your Wallbox, it is important to remove the label from the product and store it carefully!

5.4.2 View, add and delete your FLEXA AC Wallbox

To associate your Wallbox with MyFIMERwallbox App, press the icon with “+” symbol and scan the QR code on the label previously removed and taped to this manual.



Press the icon with the “+” to add a new Wallbox



Scan the QR code previously taped to the manual



The message confirms that the association was successful



Wallbox appears in the list of associated devices

- 🗨 NOTE** – The QR code provided with the Wallbox contains privileged information that allows MyFIMERwallbox App to connect with the device securely and confidentially. This automatically creates an “Admin” profile that allows all product parameters to be configured.
- 🗨 NOTE** – Once this procedure is completed, you can connect via Bluetooth by simply selecting the device.
- 🗨 NOTE** – Make sure Bluetooth is enabled on your smartphone.

Clicking on the registered Wallbox will open this screen:

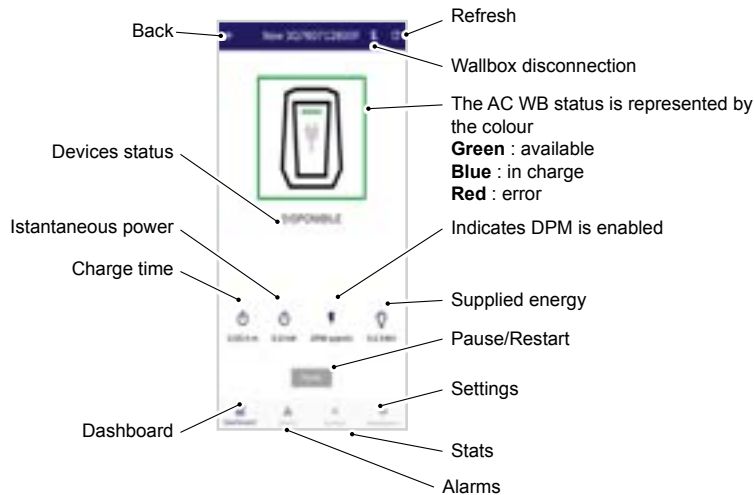

In the “Settings” section, the following operations can be done:

- Firmware upgrade
- DPM activation
- User limit setting
- Charging mode setting

5.4.3 Firmware upgrade

Scrolling through the “About” section of Settings, you will see the FW version of the device. If a new version is available, click on the arrow and start the update.

NOTE – Do not move your smartphone far from the Wallbox during the upgrade. Depending on Wallbox version, the LED may be off or pink during the update.

ATTENTION – FW upgrade in Future Net model is forbidden.

5.4.4 DPM activation

Scrolling through Settings menu you have to select the compatible meter and activate DPM. You can set your contract limit in the “DPM limit” section and your user limit in the “User limit” section.

EXAMPLES:

SINGLE-PHASE CASE

I have a 3.7 kW Wallbox, and my contractual limit is 7 kW. Since it is a single-phase version, the CT sensor is included. So in the meter section of MyFIMERwallbox App I will set “CT,” activate DPM and set the DPM limit to 7 kW (30 A). If I want to further limit the Wallbox power, I can set the user limit, for example, to 2 kW (about 8 A).

THREE-PHASE CASE

I have an 11 kW Wallbox, and my contractual limit is 15 kW. Since it is a three-phase version, the meter is not included and one compatible with this feature will have to be installed. So on the App in the meter section, I set “B23 ABB” or “M340 Gavazzi,” activate DPM and set the DPM limit per phase to 15 kW (about 21 A). If I want to further limit the Wallbox power, I set the user limit, for example, to 10 kW (about 15 A).

5.4.5 User limit setting

In case you want to limit the power delivered by the Wallbox, you can set the desired power (and current) in the “User Limit” section.

5.4.6 Charging modes

In the “Charging Mode” section, you can choose between:

- Open Access
- Remote Authorization
- RFID Mode

NOTE – “Remote authorization” mode is indicated only in case you install FIMER e4self solution, to connect Wallbox to e-smartOPT terminal.

5.4.7 Consumption

In this section, you can see all the charging sessions done with the device combined with the date and time and any associated RFID cards. This data can be shared through major social networks and via email as a text file or in “.csv” format. Graphs of charging sessions can also be visualized.



5.4.8 Monitoring consumption in multi-user applications

MyFIMERwallbox offers the possibility to manage a number of Wallboxes and users authorized for charging through two levels of authentication:

- Admin
- User

This allows, for example, in a condominium to enable with an RFID card residents to recharge their vehicle with our device, count the kWh consumed and send it to the condominium administrator. For this, the condominium administrator and/or representative will connect to the Wallbox by framing the QR code of the removable section of the label, automatically generating an Admin profile.

NOTE – You can associate more than one Admin profile with the same device.

The product must be set in the “RFID mode,” the 3 cards included with the device must be associated with it. More of these can be ordered and up to 50 can be associated with the same Wallbox.

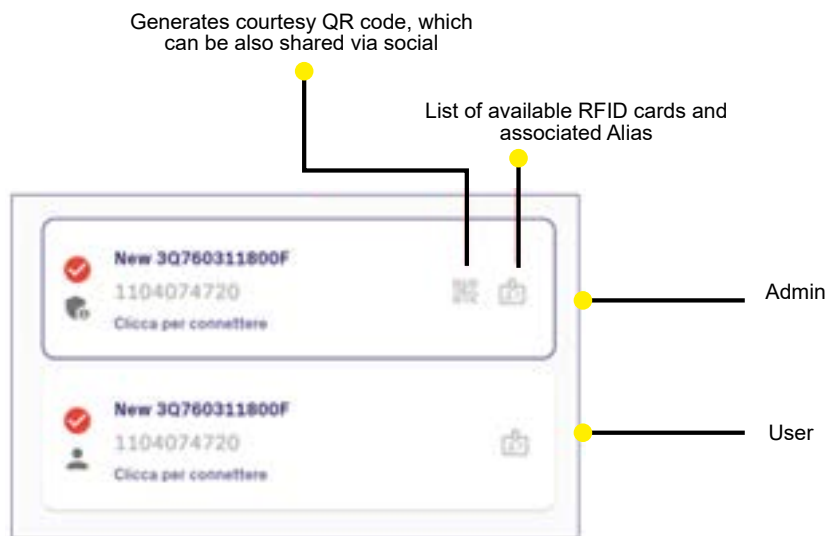

Once all the cards are associated, they can be renamed with Aliases and given to users. To allow them to use the Wallbox, the courtesy QR code must be provided. It is generated automatically and can also be shared via social by clicking on the image of the QR code (see figure above). The User after framing the courtesy QR code will be able to monitor the charging sessions of their EV by following the previously described procedure. The User profile will not have access to the Settings section of the Wallbox, so it will not be able to change any parameters of the device. However, the User can view alarms and consumption and share both via social and email.

5.4.9 Active alarms

In the “Alarms” section, you can visualize current active alarms and share them with major social networks.

NOTE – In case of alarm, refer to the “Alarms and warnings” section of this manual to consult troubleshooting operations. Alternatively, contact FIMER’s service.

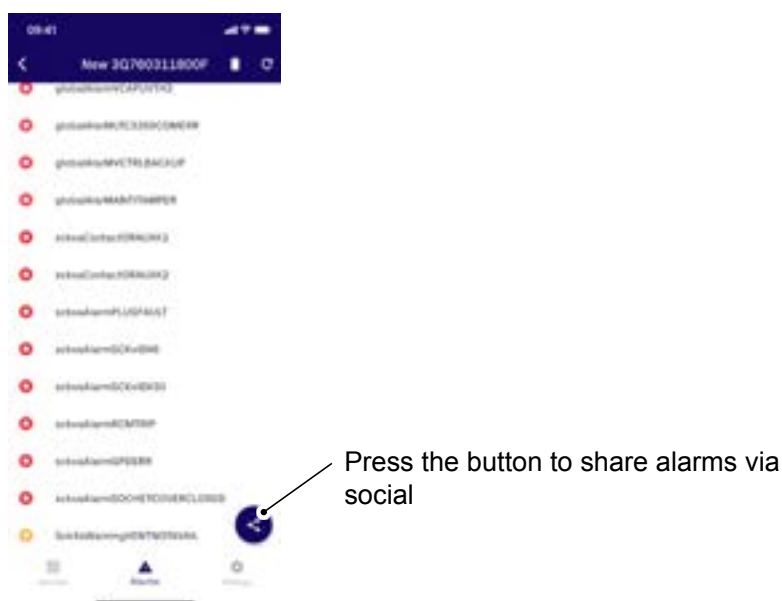



6. Troubleshooting

6

 **ATTENTION** – All versions of the device are equipped with a diagnostic and alarm system.

 **READ THE MANUAL** – Notification of faults or alarms is via the large front LED, which turns RED if an alarm is detected.

 **READ THE MANUAL** – In the event of an error, the charging session is interrupted, and the socket is immediately unlocked (SOCKET version).

 **READ THE MANUAL** – If the cause of the fault can be attributed to the electric vehicle, after disconnecting the charging cable in use, the device performs several test cycles which, if they confirm the correct functioning of all the internal components, restores functionality by restoring a fixed GREEN colour to the LED on the front. Otherwise, the LED remains RED and charging is no longer available on that device until the problem is resolved.

6.1 Alarms and warnings

The alarms are decoded by the device as records on the internal ModBus map of the device. The map is accessible via the RS-485 and Bluetooth interfaces (ModBus RTU protocol) and for the Future NET version also on the Ethernet interface (ModBus TCP protocol).

- **Meaning:** identification of the alarm or warning message. Each name begins with **GA** for Global Alarm, **GW** for Global Warning, **SCKxA** for Socket alarm and **SCKxW** for Socket Warning.
- **Error code:** identification code of the alarm or warning message as displayed on the user interface (Mobile App or Installation Tool)
- **Message:** description of the alarm or warning message as displayed in the user interface (Mobile App or Installation Tool)

6.1.1 Global alarms

Name	Error code	Message	Troubleshooting
GA_12V_UV	E001	Undervoltage 12V	Supply electrical power.
GA_12V_OV	E002	Overvoltage 12V	Supercap hardware problem.
GA_V_CTRL_UV	E003	Undervoltage VCTRL	Low power supply or supercap hardware problem.
GA_V_CTRL_OV	E004	Overvoltage VCTRL	Supercap hardware problem.
GA_VCAP_OV	E005	Overvoltage Supercap	Supercap hardware problem.
GA_VCAP_UV_TH2	E006	Undervoltage Supercap	Low power supply or supercap hardware problem.
GA_OPERATION_MODE_ERR	E009	Wrong register configuration	Configuration error.
GA_TC_OT_TH2	E012	Overtemperature	Wait for the wallbox to cool down.
GA_Q1_PRESENCE_ERR	E018	Presence signal error q1	Configuration error.
GA_SCAME_ERR	E019	Scame error	Configuration error.
GA_CORD_ERR	E021	Cord error	Configuration error.
GA_TEMP_COM_ERR	E024	Temperature Sensor Communication error	Hardware problem.
GA_LTC3350_COM_ERR	E025	Supercap controller communication error	Hardware problem.
GA_DPM	E028	DPM error	Remove plug. Check CT current sensor o meter.
GA_V_CTRL_BACKUP	E029	V Control Backup	Low power supply or supercap hardware problem.
GA_VCAP_UV_TH1	E030	Undervoltage Supercap Threshold 1	Low power supply or supercap hardware problem.
GA_RFID_BOARD	E049	RFID Reader error	RFID board not detected.
GA_STORAGE_ERR	E048	Storage	Firmware or Hardware problem.
GA_NONE_4	E035		
GA_NONE_5	E036		
GA_NONE_6	E037		
GA_ANTI_TAMPER	E013	Antitamper	Close the lid of the wallbox.

6.1.2 Global warnings

Name	Error code	Message	Troubleshooting
GW_12V_UV	W050	Undervoltage 12V	Supply electrical power.
GW_TC_OT_TH1	W051	TC Overtemperature TH1	Wait for the wallbox to cool down.
GW_CONFIG_PH1_PH3	W064	Configuration Phases mismatch	Check the wiring or configuration of the wallbox.
GW_PH3_PHASE_SEQUENCE	W065	Phase sequence mismatch	Reverse 2 phases at random.
GW_BLE_MAC_ERROR	W066	Bluetooth Low energy MAC error	Hardware or firmware problem.
GW_RTC	W067	Real Time Clock Warning	Update rtc time and check buffer battery.
GW_AMPROMETER	W068	External current sensor failure	Wrong configuration or comuincaton errors for external meter.

6.1.3 Socket alarms

Name	Error code	Message	Troubleshooting
SCKxA_CONTACTOR_AUX_K1	E102	SCK Contactor K1 mirror contact mismatch	Relay hardware problem.
SCKxA_CONTACTOR_AUX_K2	E103	SCK Contactor K2 mirror contact mismatch	Relay hardware problem.
SCKxA_GND_CTY	E104	SCK Ground Continuity Fault	
SCKxA_CP_SC	E105	SCK CP SC	Remove plug.
SCKxA_DIODE_FAULT	E106	SCK EV Diode Fault	Remove plug.
SCKxA_PLUG_FAULT	E110	SCK Plug Fault	Remove plug.
SCKxA_SUPPLY_OVERVOLTAGE	E111	SCK Supply Overvoltage	AC line problem.
SCKxA_I_L1_OL	E112	SCK L1 OL	Automatic recovery.
SCKxA_I_L2_OL	E113	SCK L2 OL	Automatic recovery.
SCKxA_I_L3_OL	E114	SCK L3 OL	Automatic recovery.
SCKxA_SCKx_ID_X6	E115	SCK RCM ID x6	Current leakage problem.
SCKxA_SCKx_ID_X30	E116	SCK RCM ID x30	Current leakage problem.
SCKxA_ID_ERROR	E117	SCK RCM ID error. Fail autotest.	Current leakage problem.
SCKxA_RCM_TRIP	E144	SCK RCM Trip	Current leakage problem.
SCKx_ALARM_PHASE_UNBALANCE	E120	SCK Unbalanced Phase	
SCKxA_REACTIVE_CURRENT	E122	EV41 reactive current	Remove plug.
SCKxA_GPD_ERR	E145	SCK GPD error	Ground problem.
SCKxA_CP_OPEN_CIRCUIT	E146	SCK CP Open Circuit	Remove plug.
SCKxA_SIMP_NO_1PH_HALT	E147	SCK Simple halt	The simplified mode only supports single phase mode.
SCKxA_DEVICECFG_WRONG_HALT	E148	SCK Wrong halt	Make single-phase connection.
SCKxA_SOCKET_SHUTTER	E149	SCK Cover close	Remove plug and close cover socket.

6.1.4 Socket warnings

Name	Error code	Message	Troubleshooting
SCKxW_PPHIGHTHRESHOLD	W150	SCK Proximity cable resistor hi threshold Warning	Remove plug.
SCKxW_PPLOWTHRESHOLD	W151	SCK Proximity cable resistor lo threshold Warning	Remove plug.
SCKxW_SIMP_NOT_AVAIL	W152	SCK Simple mode not enabled	Remove Plug.
SCKxW_VENT_NOT_AVAIL	W153	SCK Ventilation not enabled	Remove Plug.
SCKxW_SIMP_STOPPED	W154	Simple mode stopped	Simplified mode interrupted because not supported. Remove Plug.
SCKxW_VENT_STOPPED	W155	Ventilation stopped	Ventilation mode interrupted because not supported. Remove Plug.
SCKxW_SUPPLY_UNDERVOLTAGE	W156	SCK UV	AC line problem
SCKxW_I_Lx_OL_HALT	W157	OL Halt	Automatic recovery. If it persists, remove plug.
SCKxW_WAKEUP_IS_RUNNING	W199	Wakeup running	Automatic recovery. If it persists, remove plug.
SCKxW_MISSING_REGS_IN_EE	W200	Machine configuration corrupted	Reboot wallbox. If it persists, the eeprom is damaged.

7. Maintenance



- ⚠ **ATTENTION** – Before carrying out any maintenance work, disconnect the device from its power supply and cordon off the working area to avoid serious damage or injury.
- ⚠ **ATTENTION** – The correct functioning and the life of the product depend on the routine maintenance and control activities, at least every 6 months.
- ⚠ **ATTENTION** – A damaged or defective appliance must not be used in any way, but must immediately be replaced or repaired by qualified personnel in accordance with the manufacturer’s instructions.
- ⚠ **ATTENTION** – If a device is damaged, it is necessary to secure the product and the power supply (if possible, by disconnecting the circuit breaker upstream of the faulty product), immediately affix an appropriate warning prohibiting its use and contact a qualified technician or use one of the service channels indicated in the Assistance section.
- ⚠ **ATTENTION** – Cleaning the outside of the device is always recommended when necessary, and should be undertaken while avoiding strong jets of air or water as well as the use of soaps or detergents that are too harsh and corrosive for the materials of which the product is comprised.

For cleaning, use a soft damp cloth with a mild detergent and, when finished, wipe off any traces of moisture or liquid with a soft dry cloth.

The owner is responsible for the maintenance and condition of the product.

Maintenance must always take place in accordance with current regulations and while ensuring that people, property and animals are protected during all maintenance operations.

MAINTENANCE PLAN:

Activities	Frequency	Controls
Visual inspection of the exterior and cleaning of the cover and base	6 months	Thorough visual inspection for damage*: <ul style="list-style-type: none"> • Casing: breaks/cracks • Electric vehicle charging cables, sockets or connectors: breaks, cracks, visible wires • Label: presence and visibility • Control of external protections
Routine external visual inspection	Before each use	Quick visual check for damage and/or abnormalities*

* In case of damage or malfunction contact FIMER

- ⚠ **ATTENTION** – The product does not include any components that can be repaired or replaced independently by the user.

8. *Decommissioning and disposal*

8

The product must be used and subsequently disposed of in accordance with current legislation on the treatment of waste electrical and electronic equipment (WEEE) or any other regulations in force in the country of installation (in accordance with Directive 2012/19/EU).

- ⚠ **ATTENTION** – This product must not be disposed of along with household waste.
- ⚠ **ATTENTION** – The device may contain materials that could be recycled.
- ⚠ **ATTENTION** – Further information on disposal facilities can be obtained from local authorities.
- ⚠ **ATTENTION** – Before uninstalling and removing the device, it is necessary to disconnect the power supply from the switchboard and ensure that during all stages of decommissioning no one can access the switchboard and inadvertently switch the power supply back on.
- ⚠ **ATTENTION** – If you want to uninstall and store the device for later use, the following precautions must be observed:
 - ⚠ **ATTENTION** – Disconnect the device from its power supply
 - ⚠ **ATTENTION** – Clean the appliance and store it in its packaging once it is completely dry
 - ⚠ **ATTENTION** – Observe the environmental storage conditions as shown in the table in the section Available Models and Versions



For more information
please contact
your local FIMER
representative or visit:

fimer.com

We reserve the right to make technical changes or modify the contents of this document without prior notice. With regard to purchase orders, the agreed particulars shall prevail. FIMER does not accept any responsibility whatsoever for potential errors or possible lack of information in this document.

We reserve all rights in this document and in the subject matter and illustrations contained therein. Any reproduction, disclosure to third parties or utilization of its contents – in whole or in parts – is forbidden without prior written consent of FIMER. Copyright© 2023 FIMER. All rights reserved.