

UMG 604-PRO

Power analyser

Harmonics



Memory 128 MByte



Events



**Modbus master,
Ethernet gateway**



Homepage



**Graphic
programming**

Communication

- Profibus (DP/ V0)
- Modbus (RTU, UDP, TCP, Gateway)
- TCP/IP
- BACnet (optional)
- HTTP (configurable homepage)
- FTP (file transfer)
- SNMP
- TFTP
- NTP (time synchronisation)
- SMTP (email function)
- DHCP

Interfaces

- Ethernet
- RS232
- RS485

Accuracy of measurement

- Energy: Class 0.5S (... / 5 A)
- Current: 0.2 %
- Voltage: 0.2 %

Peak demand management (optional)

- Up to 64 switch-off stages

Power quality

- Harmonics up to 40th harmonic
- Short-term interruptions (> 20 ms)
- Transient recorder (> 50 µs)
- Starting currents (> 20 ms)
- Unbalance
- Full wave effective value recording (up to 4.5 min.)

Networks

- IT, TN, TT networks
- 3 and 4-phase networks
- Up to 4 single-phase networks

Measured data memory

- 128 MByte Flash

Programming language

- Jasic®

2 digital inputs

- Pulse input
- Logic input
- State monitoring
- HT / LT switching

2 digital outputs

- Pulse output kWh / kvarh
- Switch output
- Threshold value output
- Logic output

(expandable via external I/O modules, see FBM modules in chapter 05)

Temperature measurement

- PT100, PT1000, KTY83, KTY84

Network visualisation software

- Free GridVis®-Basic



Areas of application



- Master device for energy management systems, (e.g. ISO 50001)
- Measurement, monitoring and checking of electrical characteristics in energy distribution systems
- Consumption data acquisition
- Monitoring of the power quality (harmonics, short-term interruptions, transients, starting currents, etc.)
- Measured value transducer for building management systems or PLC
- Control tasks e.g. depending on measured value or limit values being reached
- Peak demand management
- Ethernet gateway for subordinate measurement points
- Remote monitoring

Main features



Power quality

- Harmonics analysis up to 40th harmonic
- Unbalance
- Distortion factor THD-U /THD-I
- Measurement of positive, negative and zero sequence component
- Short-term interruptions (> 20 ms)
- Logging and storage of transients (> 50 μ s)
- Start-up processes
- Fault recorder function
- Rotary field indication

DIN mounting rail (6TE): Simple and cost-optimised installation

- Mounting on a 35 mm DIN rail
- Clear cost advantages in the switch cabinet construction through lower installation and connection effort
- Simple integration into the LVDB, in machinery construction, in installation subdistribution panel for building management systems, in IT and in data centres



Modern communications architecture via Ethernet

- Rapid, cost-optimised and reliable communication through integration into an existing Ethernet architecture
- Integration in PLC systems and building management systems
- High flexibility due to the use of open standards
- Simultaneous polling of interfaces possible



Fig.: DIN rail mounting (6TE)

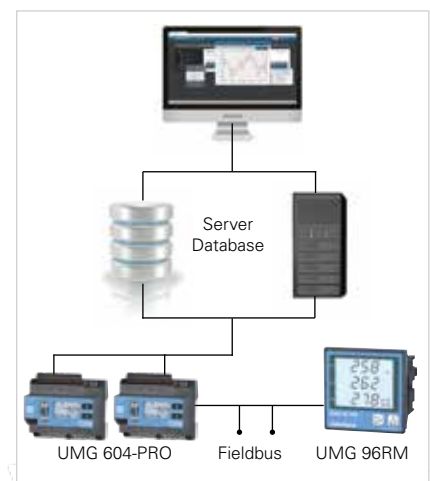
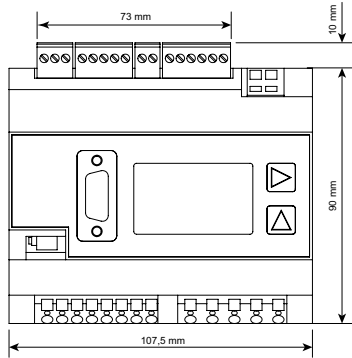

Fig.: Modern communication architecture



Dimension diagrams

All dimensions in mm



Front view

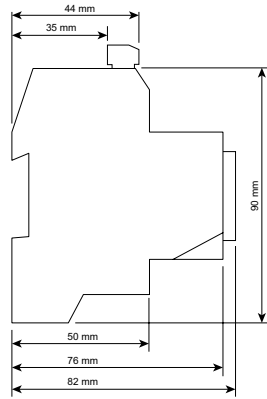

Side view



Typical connection

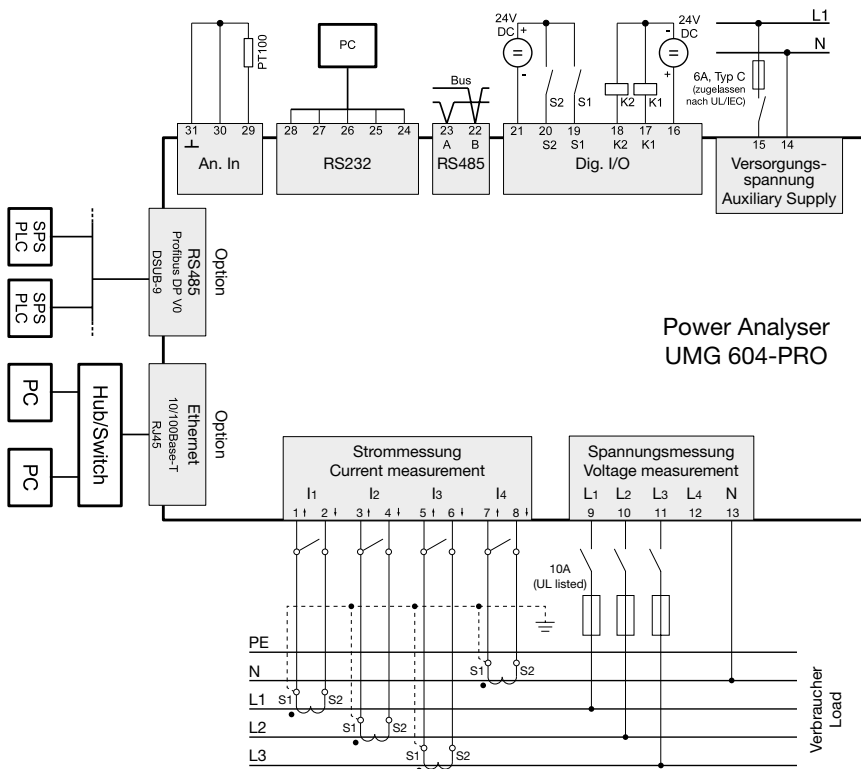



Device overview and technical data

Item number	UMG 604E-PRO			UMG 604EP-PRO	
	52.16.202	52.16.012	52.16.222	52.16.201	52.16.221
Item number (UL)	52.16.202	-	52.16.222	52.16.201	52.16.221
AC supply voltage	95 to 240 V AC	50 to 110 V AC	20 to 50 V AC	95 to 240 V AC	20 to 50 V AC
Supply voltage DC	135 to 340 V DC	50 to 155 V DC	20 to 70 V DC	135 to 340 V DC	20 to 70 V DC
Communication					
Interfaces					
RS485: 9.6 – 921.6 kbps (screw-type terminal)	•	•	•	•	•
RS232: 9.6 – 115.2 kbps (screw-type terminal)	•	•	•	•	•
Profibus DP: Up to 12 Mbps (DSUB-9 plug)	-	-	-	•	•
Ethernet 10/100 Base-TX (RJ-45 socket)	•	•	•	•	•
Protocols					
Modbus RTU, Modbus TCP, Modbus RTU over Ethernet	•	•	•	•	•
Modbus gateway for master-slave configuration	•	•	•	•	•
Profibus DP V0	-	-	-	•	•
HTTP (homepage configurable)	•	•	•	•	•
SMTP (email)	•	•	•	•	•
NTP (time synchronisation)	•	•	•	•	•
TFTP (automatic configuration)	•	•	•	•	•
FTP (file transfer)	•	•	•	•	•
SNMP	•	•	•	•	•
DHCP	•	•	•	•	•
TCP/IP	•	•	•	•	•
BACnet (optional)	•	•	•	•	•
ICMP (Ping)	•	•	•	•	•
Device options					
Emax function (peak load optimisation)	52.16.080	52.16.080	52.16.080	52.16.080	52.16.080
BACnet communication	52.16.081	52.16.081	52.16.081	52.16.081	52.16.081

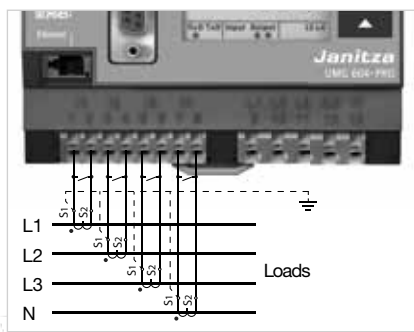

Fig.: Current measurement via current transformers

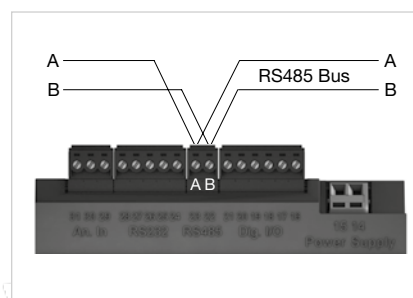

Fig.: RS485 interface, 2 pin plug contact

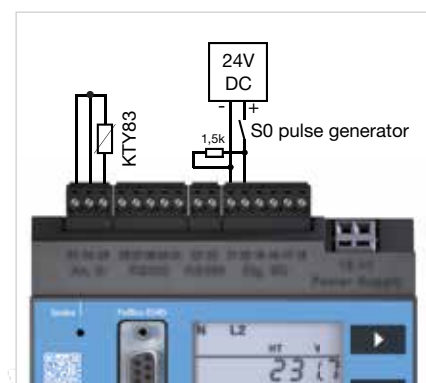

Fig.: Example temperature input (KTY83) and S0 pulse transducer

Chapter 02

UMG 604-PRO

General	
Net weight	350 g
Device dimensions	approx. l = 107.5 mm, w = 90 mm, h = 82 mm (per DIN 43871:1992)
Housing flammability rating	UL 94V-0
Installation position	any
Fastening/assembly	35 mm DIN rail (as per IEC/EN60999-1, DIN EN 50022)
Battery	Type Lithium CR2032, 3 V (approval i.a.w. UL 1642)
Service life of the backlight (optional)	40000 h (50% of the initial brightness)

Environmental conditions	
The device is intended for weatherproof, fixed installation and meets the operational conditions in accordance with DIN IEC 60721-3-3.	
Working temperature range	-10° C to +55° C
Relative humidity	5 to 95%, (at +25° C) without condensation
Pollution degree	2
Operating altitude	0 to 2000 m above sea level
Installation position	any
Ventilation	forced ventilation is not required.

Transport and storage	
The following information applies to devices which are transported or stored in the original packaging.	
Free fall	1 m
Temperature	-20° C to +70° C

Supply voltage	
The supply voltage must be connected through a UL/IEC approved fuse (6A Char. B) to the device.	
230 V option: Nominal range Operating range Power consumption Overvoltage category	95 V to 240 V (50/60 Hz) / DC 135 V to 340 V ±10% of nominal range max. 3.2 W / 9 VA 300 V CAT II
90 V option (without UL approval): Nominal range Operating range Power consumption Overvoltage category	50 V to 110 V (50/60 Hz) / DC 50 V to 155 V ±10% of nominal range max. 3.2 W / 9 VA 300 V CAT II
24V option: Nominal range Operating range Power consumption Overvoltage category	20 V to 50 V (50/60 Hz) / DC 20 V to 70 V ±10% of nominal range max. 5 W / 8 VA 150 V CAT II

Terminal connection capacity (supply voltage)	
Connectable conductors. Only one conductor can be connected per terminal!	
Single core, multi-core, fine-stranded	0.08 - 2.5 mm ² , AWG 28 - 12
Terminal pins, core end sheath	1.5 mm ² , AWG 16

Protection class	
Protection class II in accordance with IEC 60536 (VDE 0106, part 1), i.e. a ground wire connection is not required!	
Protection against ingress of solid foreign bodies and water	IP20 in accordance with EN60529 September 2014, IEC60529:2013

Digital inputs	
Maximum counter frequency (Pulse input S0)	20 Hz
Switching input	
Input signal present	18 V to 28 V DC (typical 4 mA)
Input signal not present	0 to 5 V DC, current less than 0.5 mA
Response time (Jasic program)	200 ms
Cable length	up to 30 m unshielded, from 30 m shielded

Digital outputs	
2 digital outputs; semiconductor relays, not short-circuit proof	
Switching voltage	max. 60 V DC, 30 V AC
Switching current	max. 50 mAeff AC/DC
Response time (Jasic program)	200 ms
Output of voltage dips	20 ms
Output of voltage exceedance events	20 ms
Switching frequency	max. 20 Hz
Cable length	up to 30 m unshielded, from 30 m shielded

Terminal connection capacity	
Connectable conductors.	
Single core, multi-core, fine-stranded	0.08 - 1.5 mm ²
Terminal pins, core end sheath	1 mm ² Only one conductor must be connected per terminal!

Temperature measurement input	
3-wire measurement	
Update time	Approx. 200 ms
Connectable sensors	PT100, PT1000, KTY83, KTY84
Total burden (sensor + cable)	max. 4 kOhm
Cable length	up to 30 m unshielded, from 30 m shielded

Sensor type	Temperature range	Resistor range	Measurement uncertainty
KTY83	-55 °C to +175 °C	500 Ohm to 2.6 kOhm	± 1.5% rng ¹⁾
KTY84	-40 °C to +300 °C	350 Ohm to 2.6 kOhm	± 1.5% rng ¹⁾
PT100	-99 °C to +500 °C	60 Ohm to 180 Ohm	± 1.5% rng ¹⁾
PT1000	-99 °C to +500 °C	600 Ohm to 1.8 kOhm	± 1.5% rng ¹⁾

¹⁾ rng = metering range

Terminal connection capacity (temperature measurement input)	
Single core, multi-core, fine-stranded	0.08 - 1.5 mm ²
Terminal pins, core end sheath	1 mm ² Only one conductor must be connected per terminal!

Chapter 02

UMG 604-PRO

Voltage measurement inputs	
Three-phase 4-conductor systems (L-N/L-L)	max. 277 V / 480 V
Three-phase 3-conductor systems (L-L)	max. 480 V
Resolution	0.01 V
Metering range L-N	0 ¹⁾ to 600 V _{rms}
Metering range L-L	0 ¹⁾ to 1000 V _{rms}
Crest factor	2 (related to 480 V _{rms})
Overvoltage category	300 V CAT III
Measurement voltage surge	4 kV
Protection of voltage measurement	1 - 10 A
Impedance	4 MOhm / phase
Power consumption	approx. 0.1 VA
Sampling rate	20 kHz / phase
Transients	> 50 μs
Frequency of the fundamental oscillation	45 Hz to 65 Hz
- Resolution	0.001 Hz

¹⁾The UMG device can only determine measured values, if an L-N voltage of greater than 10 V_{eff} or an L-L voltage of greater than 18 V_{eff} is applied to at least one voltage measurement input.

Current measurement inputs	
Rated current	5 A
Rated current	6 A
Protection when measuring directly (without a current transformer)	6 A, char. B (approved i.a.w. UL/IEC)
Resolution on the display	10 mA
Metering range	0.005 to 7 A _{rms}
Crest factor	2 (related to 6 A _{rms})
Overvoltage category	300 V CAT III
Measurement voltage surge	4 kV
Power consumption	approx. 0.2 VA (R _i = 5 MOhm)
Overload for 1 sec.	100 A (sinusoidal)
Sampling rate	20 kHz
Phase angle accuracy of measurement	0.15°

Terminal connection capacity (current measurement and voltage measurement)	
Connectable conductors. Only one conductor can be connected per terminal!	
Single core, multi-core, fine-stranded	0.08 - 4 mm ² , AWG 28 - 12
Terminal pins, core end sheath	2.5 mm ² , AWG 14

RS232 interface	
Connection	5-pin screw-type terminals
Protocol	Modbus RTU/slave
Transmission rate	9.6 kbps, 19.2 kbps, 38.4 kbps, 57.6 kbps, 115.2 kbps

RS485 interface	
Connection	2-pin screw-type terminals
Protocol	Modbus RTU/slave, Modbus RTU/master
Transmission rate	9.6 kbps, 19.2 kbps, 38.4 kbps, 57.6 kbps, 115.2 kbps, 921.6 kbps

Profibus interface (optional)	
Connection	SUB D 9-pole
Protocol	Profibus DP/V0 per EN 50170
Transmission rate	9.6 kBaud to 12 MBaud

Ethernet interface	
Connection	RJ45
Function	Modbus gateway, embedded web server (HTTP)
Protocols	TCP/IP, EMAIL (SMTP), DHCP client (BootP), Modbus/TCP(port 502), ICMP (ping), NTP, TFTP, Modbus RTU over Ethernet (port 8000), FTP SNMP.

Measurement uncertainty		
Measurement uncertainty on the device applies when using the following metering ranges. The measured value must be within the specified limits. The measurement uncertainty is not specified outside of these limits.		
Measured value	Measurement uncertainties	
Voltage	± 0.2%	as per DIN EN 61557-12:2008
Current L	± 0.25%	in accordance with DIN EN 61557-12:2008
Current N	± 1%	as per DIN EN 61557-12:2008
Power	± 0.4%	as per DIN EN 61557-12:2008
Harmonics U, I	Class 1, DIN EN 61000-4-7	
Active energy		
Current transformer ..5 A	Class 0.5S	(DIN EN62053-22:2003, IEC62053:22:2003)
Current transformer ..1 A	Class 1	(DIN EN62053-21:2003, IEC62053:21:2003)
Reactive energy		
Current transformer ..5 A	Class 2	(DIN EN62053-23:2003, IEC62053:23:2003)
Current transformer ..1 A	Class 2	(DIN EN62053-23:2003, IEC62053:23:2003)
Frequency	± 0.01 Hz	
Internal clock	±1 minute/month (18° C to 28° C)	

The specification applies under the following conditions:

- annual re-calibration,
- a warm-up time of 10 minutes,
- an ambient temperature of 18 to 28° C.

If the device is operated outside the range of 18 to 28° C, an additional measuring error of ±0.01% of the measured value per °C deviation must be taken into account.

Firmware	
Firmware update	Update via GridVis® software. Firmware download (free of charge) from the website: http://www.janitza.com

Comment: For detailed technical information please refer to the operation manual and the Modbus address list.

Chapter 02
UMG 604-PRO

